

FINAL REPORT

**DEVELOPMENT AND TESTING OF A
NEW VERTICAL-FACED TEMPORARY
CONCRETE BARRIER FOR USE ON
COMPOSITE PANEL BRIDGE DECKS**

Submitted by

Jennifer D. Schmidt, B.S.C.E., E.I.T.
Graduate Research Assistant

Ronald K. Faller, Ph.D., P.E.
Research Assistant Professor

Karla A. Lechtenberg, M.S.M.E., E.I.T.
Research Associate Engineer

Dean L. Sicking, Ph.D., P.E.
Professor and MwRSF Director

John D. Reid, Ph.D.
Professor

MIDWEST ROADSIDE SAFETY FACILITY

University of Nebraska-Lincoln
527 Nebraska Hall
Lincoln, Nebraska 68588-0529
(402) 472-0965

Submitted to

KANSAS DEPARTMENT OF TRANSPORTATION

Bureau of Materials and Research
2300 S.W. Van Buren Street
Topeka, Kansas 66611-1195

MwRSF Research Report No. TRP-03-220-09

October 13, 2009

TECHNICAL REPORT DOCUMENTATION PAGE

1. Report No. TRP-03-220-09	2.	3. Recipient's Accession No.	
4. Title and Subtitle Development and Testing of a New Vertical-Faced Temporary Concrete Barrier for Use on Composite Panel Bridge Decks		5. Report Date October 13, 2009	
		6.	
7. Author(s) Schmidt, J.D., Faller, R.K., Lechtenberg, K.A., Sicking, D.L., and Reid, J.D.		8. Performing Organization Report No. TRP-03-220-09	
9. Performing Organization Name and Address Midwest Roadside Safety Facility (MwRSF) University of Nebraska-Lincoln 527 Nebraska Hall Lincoln, Nebraska 68588-0529		10. Project/Task/Work Unit No.	
		11. Contract © or Grant (G) No.	
12. Sponsoring Organization Name and Address Kansas Department of Transportation Bureau of Materials and Research 2300 S.W. Van Buren Street Topeka, Kansas 66611-1195		13. Type of Report and Period Covered Final Report: 2008 – 2009	
		14. Sponsoring Agency Code SPR-3(017), Supplement #57	
15. Supplementary Notes Prepared in cooperation with U.S. Department of Transportation, Federal Highway Administration.			
16. Abstract (Limit: 200 words) Fiber Reinforced Polymer (FRP) composite materials have become more readily used in bridge decks. However, no acceptable bridge railing systems have been developed for use on these composite panel bridges. The Kansas Department of Transportation sponsored the development and testing of a precast, vertical-faced, concrete barrier system for attachment to a composite panel bridge deck. The barrier segments were fastened to the deck panels using eight 1-in. (25-mm) diameter Grade 5 anchor rods and nuts. An 18-in. long x 8-in. wide x ½-in. thick (457-mm x 203-mm x 13-mm) ASTM A36 steel plate washer was located at the bottom of the deck at each set of two anchor bolt positions. One full-scale vehicle crash test was performed on the bridge railing system using a ½-ton, Quad Cab pickup truck at an impact speed of 61.1 mph (98.4 km/h) and an impact angle of 25.9 degrees. The test was conducted and reported in accordance with the Test Level 3 (TL-3) requirements specified in the <i>Manual for Assessing Safety Hardware</i> (MASH). The vertical-faced, temporary concrete barrier system attached to an FRP composite bridge deck met to the TL-3 evaluation criteria specified in MASH.			
17. Document Analysis/Descriptors Roadside Safety, Crash Test, Compliance Test, Longitudinal Barrier, Concrete Barrier, Composite Bridge Deck, FRP, Roadside Appurtenances, MASH, Vertical Barrier		18. Availability Statement No restrictions. Document available from: National Technical Information Services, Springfield, Virginia 22161	
19. Security Class (this report) Unclassified	20. Security Class (this page) Unclassified	21. No. of Pages 101	22. Price

DISCLAIMER STATEMENT

This report was funded in part through grant(s) from Kansas Department of Transportation and the Federal Highway Administration, U.S. Department of Transportation. The contents of this report reflect the views and opinions of the authors who are responsible for the facts and the accuracy of the data presented herein. The contents do not necessarily reflect the official views or policies of the Kansas Department of Transportation nor the Federal Highway Administration, U.S. Department of Transportation. This report does not constitute a standard, specification, regulation, product endorsement, or an endorsement of manufacturers.

UNCERTAINTY OF MEASUREMENT STATEMENT

The Midwest Roadside Safety Facility (MwRSF) has determined the uncertainty of measurements for several parameters involved in standard full-scale crash testing and non-standard testing of roadside safety features. Information regarding the uncertainty of measurements for critical parameters is available upon request by the sponsor and the Federal Highway Administration.

ACKNOWLEDGEMENTS

The authors wish to acknowledge several sources that made a contribution to this project: (1) Kansas Department of Transportation for sponsoring this project and supplying the concrete parapets; (2) Kansas Structural Composites, Inc. of Russell, Kansas for supplying the FRP bridge deck panels, installing the deck panels and barriers, and providing project guidance; (3) BG Consultants, Inc. of Manhattan, Kansas for designing the modified temporary concrete barrier and project support; (4) Texas Transportation Institute, Texas A&M University, College Station, Texas for the X-bolt connection details used with temporary concrete barriers; and (5) MwRSF personnel for design input, assisting with construction, as well as conducting the full-scale vehicle crash test.

Acknowledgement is also given to the following individuals who made a contribution to the completion of this research project.

Midwest Roadside Safety Facility

J.R. Rohde, Ph.D., P.E., Associate Professor
J.C. Holloway, M.S.C.E., E.I.T., Test Site Manager
R.W. Bielenberg, M.S.M.E., E.I.T., Research Associate Engineer
S.K. Rosenbaugh, M.S.C.E., E.I.T., Research Associate Engineer
C.L. Meyer, B.S.M.E., E.I.T., Research Associate Engineer
A.T. Russell, B.S.B.A., Shop Manager
K.L. Krenk, B.S.M.A, Maintenance Mechanic
Tom McMaster, Laboratory Mechanic
Undergraduate and Graduate Research Assistants

Kansas Department of Transportation

David E. Meggers, P.E., Research Development Engineer

Kansas Structural Composites, Inc. (KSCI)

Jerry D. Plunkett, Ph.D., President, CEO

BG Consultants. Inc.

Moni G. El-Aasar, Ph.D., P.E., Vice President

TABLE OF CONTENTS

TECHNICAL REPORT DOCUMENTATION PAGE i

DISCLAIMER STATEMENT ii

UNCERTAINTY OF MEASUREMENT STATEMENT ii

ACKNOWLEDGEMENTS iii

TABLE OF CONTENTS v

LIST OF FIGURES vii

LIST OF TABLES ix

1 INTRODUCTION 1

 1.1 Problem Statement 1

 1.2 Objectives 1

 1.3 Scope 2

2 LITERATURE REVIEW 3

3 DESIGN DETAILS 4

4 TEST REQUIREMENTS AND EVALUATION CRITERIA 24

 4.1 Test Requirements 24

 4.2 Evaluation Criteria 25

5 TEST CONDITIONS 27

 5.1 Test Facility 27

 5.2 Vehicle Tow and Guidance System 27

 5.3 Test Vehicles 27

 5.4 Data Acquisition Systems 32

 5.4.1 Accelerometers 32

 5.4.2 Rate Transducers 33

 5.4.3 Pressure Tape Switches 34

 5.4.4 High-Speed Photography 34

6 FULL SCALE CRASH TEST NO. KSFRP-1 36

 6.1 Test No. KSFRP-1 36

 6.2 Weather Conditions 36

 6.3 Test Description 36

 6.4 System Damage 38

 6.5 Vehicle Damage 39

 6.6 Occupant Risk 40

 6.7 Discussion 41

7 SUMMARY, CONCLUSIONS, AND RECOMMENDATIONS..... 59

8 REFERENCES 61

9 APPENDICES 62

 Appendix A. Material Specifications..... 63

 Appendix B. Vehicle Center of Gravity Determination..... 72

 Appendix C. Vehicle Deformation Records 74

 Appendix D. Accelerometer and Rate Transducer Data Plots, Test No. KSFRP-1..... 80

LIST OF FIGURES

Figure 1. Test Installation Layout, Test No. KSFRP-1.....	7
Figure 2. Test Installation Layout, Test No. KSFRP-1.....	8
Figure 3. Test Installation Layout, Test No. KSFRP-1.....	9
Figure 4. Test Installation Layout, Test No. KSFRP-1.....	10
Figure 5. Concrete Barrier Details, Test No. KSFRP-1.....	11
Figure 6. Concrete Barrier Connection Details, Test No. KSFRP-1.....	12
Figure 7. Concrete Barrier Connection Hardware Details, Test No. KSFRP-1.....	13
Figure 8. Concrete Barrier Reinforcement Details, Test No. KSFRP-1.....	14
Figure 9. Reinforcement Specifications, Test No. KSFRP-1.....	15
Figure 10. FRP Panel Details, Test No. KSFRP-1.....	16
Figure 11. FRP Details, Test No. KSFRP-1.....	17
Figure 12. Test Installation, Test No. KSFRP-1.....	18
Figure 13. Test Installation, Test No. KSFRP-1.....	19
Figure 14. Barrier System, Test No. KSFRP-1.....	20
Figure 15. Barrier Connection Joints, Test No. KSFRP-1.....	21
Figure 16. Barrier Anchorage System, Test No. KSFRP-1.....	22
Figure 17. Composite Deck Panel Connection, Test No. KSFRP-1.....	23
Figure 18. Test Vehicle, Test No. KSFRP-1.....	28
Figure 19. Vehicle Dimensions, Test No. KSFRP-1.....	29
Figure 20. Target Geometry, Test No. KSFRP-1.....	31
Figure 21. Camera Locations, Speeds, and Lens Settings, Test No. KSFRP-1.....	35
Figure 22. Summary of Test Results and Sequential Photographs, Test No. KSFRP-1.....	43
Figure 23. Additional Sequential Photographs, Test No. KSFRP-1.....	44
Figure 24. Additional Sequential Photographs, Test No. KSFRP-1.....	45
Figure 25. Documentary Photographs, Test No. KSFRP-1.....	46
Figure 26. Impact Location, Test No. KSFRP-1.....	47
Figure 27. Vehicle's Final Position and Trajectory Marks, Test No. KSFRP-1.....	48
Figure 28. System Damage, Test No. KSFRP-1.....	49
Figure 29. Barrier No. 2 Damage, Test No. KSFRP-1.....	50
Figure 30. Joint Damage Between Barrier Nos. 2 and 3, Test No. KSFRP-1.....	51
Figure 31. Panel Shift - Joints 3 and 4 (Top) and 4 and 5 (Bottom), Test No. KSFRP-1.....	52
Figure 32. Panel Joints 2 and 3 (Top) and 4 and 5 (Bottom) Damage, Test No. KSFRP-1.....	53
Figure 33. Vehicle Damage, Test No. KSFRP-1.....	54
Figure 34. Vehicle Damage, Test No. KSFRP-1.....	55
Figure 35. Vehicle Damage, Test No. KSFRP-1.....	56
Figure 36. Interior Occupant Compartment Deformation, Test No. KSFRP-1.....	57
Figure 37. Impact Forces Imparted to the Barrier System, Test No. KSFRP-1.....	58
Figure A-1. Barrier Materials.....	64
Figure A-2. Barrier Aggregate Specifications.....	65
Figure A-3. Barrier Aggregate Specifications.....	66
Figure A-4. Barrier Aggregate Specifications.....	67
Figure A-5. Cement Specifications.....	68
Figure A-6. Cement Specifications.....	69

Figure A-7. Cement Specifications.....	70
Figure A-8. Cement Specifications.....	71
Figure B-1. Vehicle Mass Distribution, Test No. KSFRP-1.....	73
Figure C-1. Floor Pan Deformation Data – Set 1, Test No. KSFRP-1	75
Figure C-2. Floor Pan Deformation Data – Set 2, Test No. KSFRP-1	76
Figure C-3. Occupant Compartment Deformation Index, Test No. KSFRP-1	77
Figure C-4. Exterior Vehicle Crush (NASS) - Front, Test No. KSFRP-1	78
Figure C-5. Exterior Vehicle Crush (NASS) - Side, Test No. KSFRP-1	79
Figure D-1. 10-ms Average Longitudinal Deceleration (EDR-3), Test No. KSFRP-1	81
Figure D-2. Longitudinal Occupant Impact Velocity (EDR-3), Test No. KSFRP-1	82
Figure D-3. Longitudinal Occupant Displacement (EDR-3), Test No. KSFRP-1.....	83
Figure D-4. 10-ms Average Lateral Deceleration (EDR-3), Test No. KSFRP-1	84
Figure D-5. Lateral Occupant Impact Velocity (EDR-3), Test No. KSFRP-1	85
Figure D-6. Lateral Occupant Displacement (EDR-3), Test No. KSFRP-1	86
Figure D-7. 10-ms Average Longitudinal Deceleration (EDR-4), Test No. KSFRP-1	87
Figure D-8. Longitudinal Occupant Impact Velocity (EDR-4), Test No. KSFRP-1	88
Figure D-9. Longitudinal Occupant Displacement (EDR-4), Test No. KSFRP-1.....	89
Figure D-10. 10-ms Average Lateral Deceleration (EDR-4), Test No. KSFRP-1	90
Figure D-11. Lateral Occupant Impact Velocity (EDR-4), Test No. KSFRP-1	91
Figure D-12. Lateral Occupant Displacement (EDR-4), Test No. KSFRP-1	92
Figure D-13. Vehicle Angular Displacements (EDR-4), Test No. KSFRP-1	93
Figure D-14. 10-ms Average Longitudinal Deceleration (DTS), Test No. KSFRP-1.....	94
Figure D-15. Longitudinal Occupant Impact Velocity (DTS), Test No. KSFRP-1	95
Figure D-16. Longitudinal Occupant Displacement (DTS), Test No. KSFRP-1	96
Figure D-17. 10-ms Average Lateral Deceleration (DTS), Test No. KSFRP-1	97
Figure D-18. Lateral Occupant Impact Velocity (DTS), Test No. KSFRP-1	98
Figure D-19. Lateral Occupant Displacement (DTS), Test No. KSFRP-1.....	99
Figure D-20. Vehicle Angular Displacements (DTS), Test No. KSFRP-1	100

LIST OF TABLES

Table 1. MASH TL-3 Crash Test Conditions 25
Table 2. MASH Evaluation Criteria for Longitudinal Barriers 26
Table 3. Weather Conditions, Test No. KSFRP-1 36
Table 4. Time-Sequential Description of Impact Events, Test No. KSFRP-1 37
Table 5. Summary of OIV, ORA, THIV, and PHD Values, Test No. KSFRP-1 41
Table 6. Summary of Safety Performance Evaluation Results 60

1 INTRODUCTION

1.1 Problem Statement

In recent years, Fiber Reinforced Polymer (FRP) composite materials have been used in the fabrication of light-weight, corrosion-resistant, environmentally-sound, honeycomb sandwich bridge deck panels. These FRP deck panels have been considered as a replacement for steel reinforced concrete bridge decks that have encountered deterioration or have been used to allow existing bridge structures to meet current American Association of State Highway and Transportation Officials (AASHTO) design loading, thus extending the life of the existing bridge system. It has been estimated that FRP deck panels have a design life of approximately 100 years. In addition, an FRP deck panel weighs approximately 75 to 85 percent less than comparable bridge deck products configured with concrete and steel. Bridges constructed with FRP materials have shorter construction times, since the deck panels are fabricated offsite and delivered to the bridge site for a timely installation, which reduces the period over which the bridge is closed for repairs.

Although FRP honeycomb sandwich panels have been considered as a replacement for typical bridge decks, there are no crashworthy, temporary barrier systems available for use on composite panel bridge decks. Bridge engineers and researchers at the Kansas Department of Transportation (KDOT) have a need for a crashworthy bridge railing system for use on light-weight, FRP bridge decks which will meet the safety performance criteria found in the *Manual for Assessing Safety Hardware* (MASH) (1).

1.2 Objectives

The research objectives were to develop, test, and evaluate a vertical-faced, temporary concrete barrier for use on FRP composite bridge decks. The barrier system was to be full-scale

vehicle crash tested according to the Test Level 3 (TL-3) safety performance criteria set forth in MASH.

1.3 Scope

The research objectives were achieved by performing several tasks. First, the new concrete barrier section was designed by Dr. Moni G. El-Aasar, P.E. of BG Consultants, Inc., in cooperation with researchers at the Midwest Roadside Safety Facility (MwRSF). Next, temporary concrete barrier sections were fabricated and shipped to Lincoln, Nebraska for use in the testing and evaluation program. A full-size test bridge was installed using reinforced concrete bents and abutments, steel girders, and FRP deck panels. The temporary concrete barriers were then attached to the outside edge of the FRP deck panels. One full-scale vehicle crash test was performed using a ½-ton, 2-wheel drive, four-door, Quad Cab pickup truck weighing approximately 5,004 lbs (2,270 kg). The target impact speed and angle for the crash test were 62 mph (100 km/h) and 25 degrees, respectively. Finally, the test results were analyzed, evaluated, and documented. Conclusions and recommendations were made that pertain to the safety performance of the precast concrete barrier segments when attached to an FRP composite bridge deck system.

2 LITERATURE REVIEW

In 2004, the Kansas Department of Transportation, BG Consultants, Inc. and the Midwest Roadside Safety Facility (MwRSF) cooperated in a research study to develop a New Jersey, safety shape, temporary concrete barrier for use on a FRP composite bridge deck system (2). For this effort, the concrete barrier segments were configured using a 7 ft – 4½ in. (2.25 m) length with a pin and loop type connection between each barrier end. Each FRP panel was 7 ft – 11½ in. (2.43 m) wide. The barrier system was full-scale crash tested using test designation no. 3-11 provided in the National Cooperative Highway Research Program (NCHRP) Report No. 350 (3). The 4,470-lb (2,028-kg) pickup truck impacted the center of a barrier at an impact speed and angle of 62.3 mph (100.2 km/h) and 26.0 degrees, respectively. The deck panels deflected downward and backward as the right-front corner of the truck protruded over the barrier system. The pickup truck's right-rear tire snagged on the upstream end of a barrier segment, thus causing significant pitch and roll for the vehicle. Subsequently, the vehicle rolled over as it was redirected away from the system. Several factors were deemed to have contributed to the failure of the barrier system, including: (1) a large joint width between barriers; (2) the transverse slack between the inner loops and the drop pin; (3) each barrier was connected to only one panel; and (4) the steel plate detail used to attach the deck panels to the girders may have allowed additional panel shift. Additional discussion on this effort is provided in Reference (2).

3 DESIGN DETAILS

The test installation was 92 ft (28.04 m) long and consisted of vertical-faced, temporary concrete barrier segments attached to FRP composite bridge deck panels, as shown in Figures 1 through 11. The six 15-ft 4-in. (4.67-m) long barriers were 16 in. and 9 in. (406 mm and 229 mm) wide at the base and the top, respectively, with a 32-in. (813-mm) top mounting height, as measured from the top of the FRP composite bridge deck to the top of the barrier. Photographs of the test installation are shown in Figures 12 through 17. Material specifications, mill certifications, and certificates of conformity for the system materials are shown in Appendix A.

The barrier segments were fabricated using air entrained concrete, with a minimum 28-day compressive strength of 5,000 psi (34.5 MPa). A minimum concrete cover of 1½ in. (38 mm) was used for all steel reinforcement. The steel reinforcement consisted of ASTM A615 Grade 60 rebar. Each barrier segment utilized ten longitudinal bars, 46 vertical stirrups, and 23 base loops, as shown in Figures 5, 8, and 9.

An X-joint, tie rod assembly was used to connect the ends of adjoining barrier segments, as shown in Figures 6 and 7. The tie rods were made from ⅞-in. (22.2-mm) diameter, Grade 5 round bar with a plate washer and nut at each end. The upper and lower tie rods were 26½ in. (673 mm) and 30 in. (762 mm) long, respectively.

Each barrier segment was fastened to the FRP composite bridge deck with eight 1-in. (25-mm) diameter x 19-in. (483-mm) long, Grade 5 anchor rods with heavy hex nuts. An 18-in. long x 8-in. wide x ½-in. thick (457-mm x 203-mm x 13-mm) ASTM A36 steel plate washer was located between the bottom of the deck and the hex nuts at each set of two anchor rod positions, as shown in Figures 5 and 8. The back-side toe of each barrier segment was placed 3⅜ in. (86 mm) away from the back edge of the FRP bridge deck panels.

The FRP bridge deck panels were placed transversely across two rows of longitudinal steel bridge girders. Each FRP panel measured 14 ft – 5 in. long x 7 ft – 11½ in. wide x 8 in. thick (4.39 m x 2.43 m x 203 mm). Each panel surface was fabricated using ½-in. (13-mm) thick elements configured with 40 percent fiberglass and 60 percent polyester. The fiber architecture utilized a standard Kansas Structural Composites, Inc. (KSCI) lay-up in conjunction with a polyester resin material. A honeycomb core, shown in Figure 11, was used for the panels and consisted of alternating flat and corrugated layers. The flat FRP elements were 0.09-in. (2.3-mm) thick, while the corrugated layers had a 2-in. (51-mm) amplitude and a wave length of 4.0. The core height was 7 in. (178 mm). The panel edges and close outs were configured with 0.12-in. (3.0-mm) thick FRP elements and wet lay ups of 4 to 6 in. (102 to 152 mm) overlapping on the primary surfaces. The panel to support beam connections utilized bent steel plate connectors which measured ¼ in. (6 mm) thick by 5 in. (127 mm) wide. The connector plates were anchored with 1-in. (25-mm) diameter studs welded to the beams with washers and nuts at panel joints. It was recommended that the anchor studs be attached with a full-penetration weld and using a stud gun. The low-carbon steel anchor studs had a 50 ksi (345 MPa) minimum yield strength and a 60 ksi (414 MPa) minimum tensile strength and were manufactured by Sunbelt Stud Welding, Inc., of Houston, Texas.

It should be noted that the barrier segments were anchored to the FRP deck panels using an arrangement where the upstream end of barrier no. 1 was aligned with the upstream end of panel no. 1. With this configuration, a barrier joint occurred close to a panel joint at the end of barrier segment no. 2, and a vertical anchor rod was located close to the deck joint between panel nos. 4 and 5. As discussed later, initial vehicle impact was to occur 4 ft – 3¼ in. (1.30 m)

upstream from the center of the joint between barrier nos. 2 and 3 in order to maximize the impact loading imparted to barrier system at this critical location.

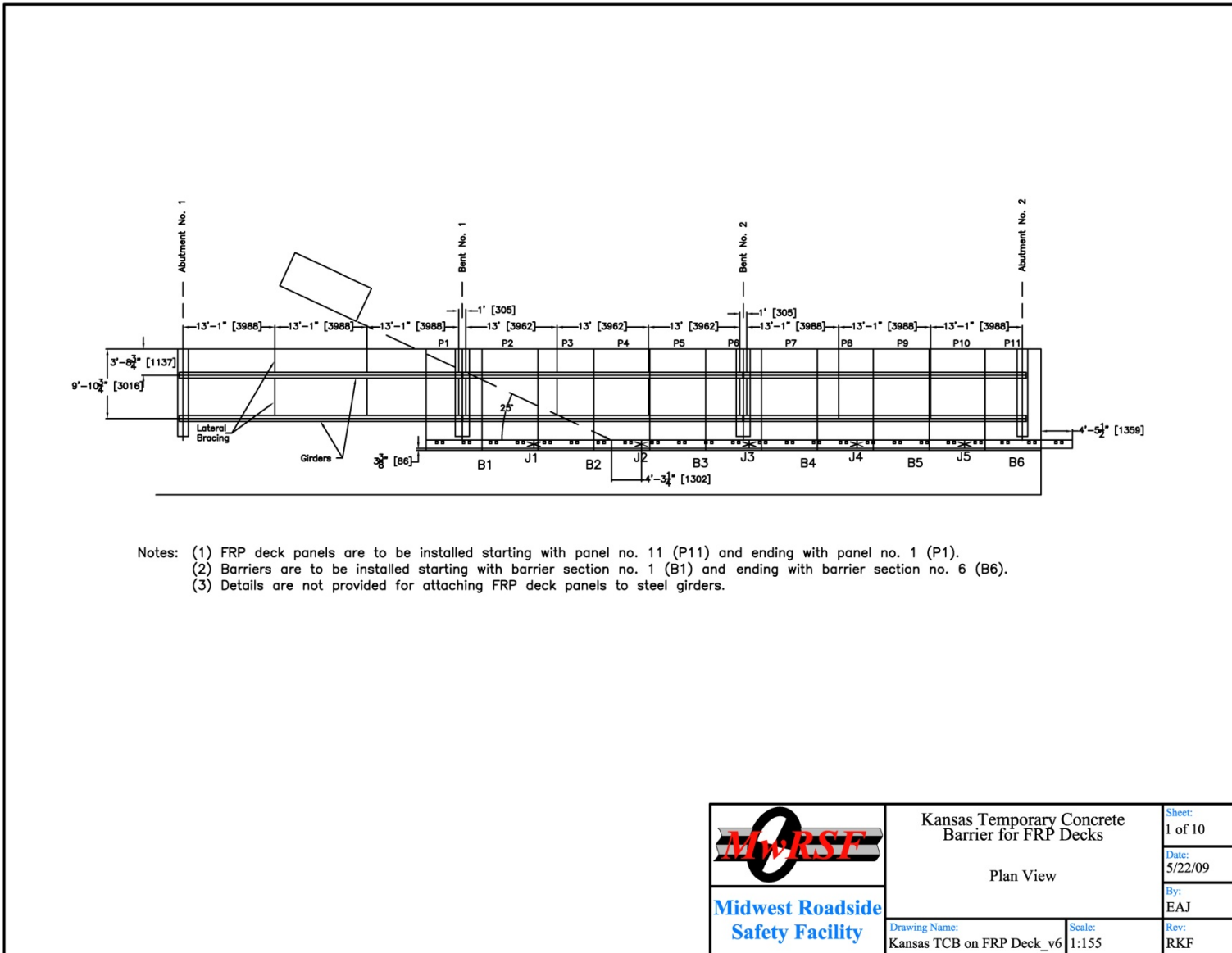

Figure 1. Test Installation Layout, Test No. KSFRP-1

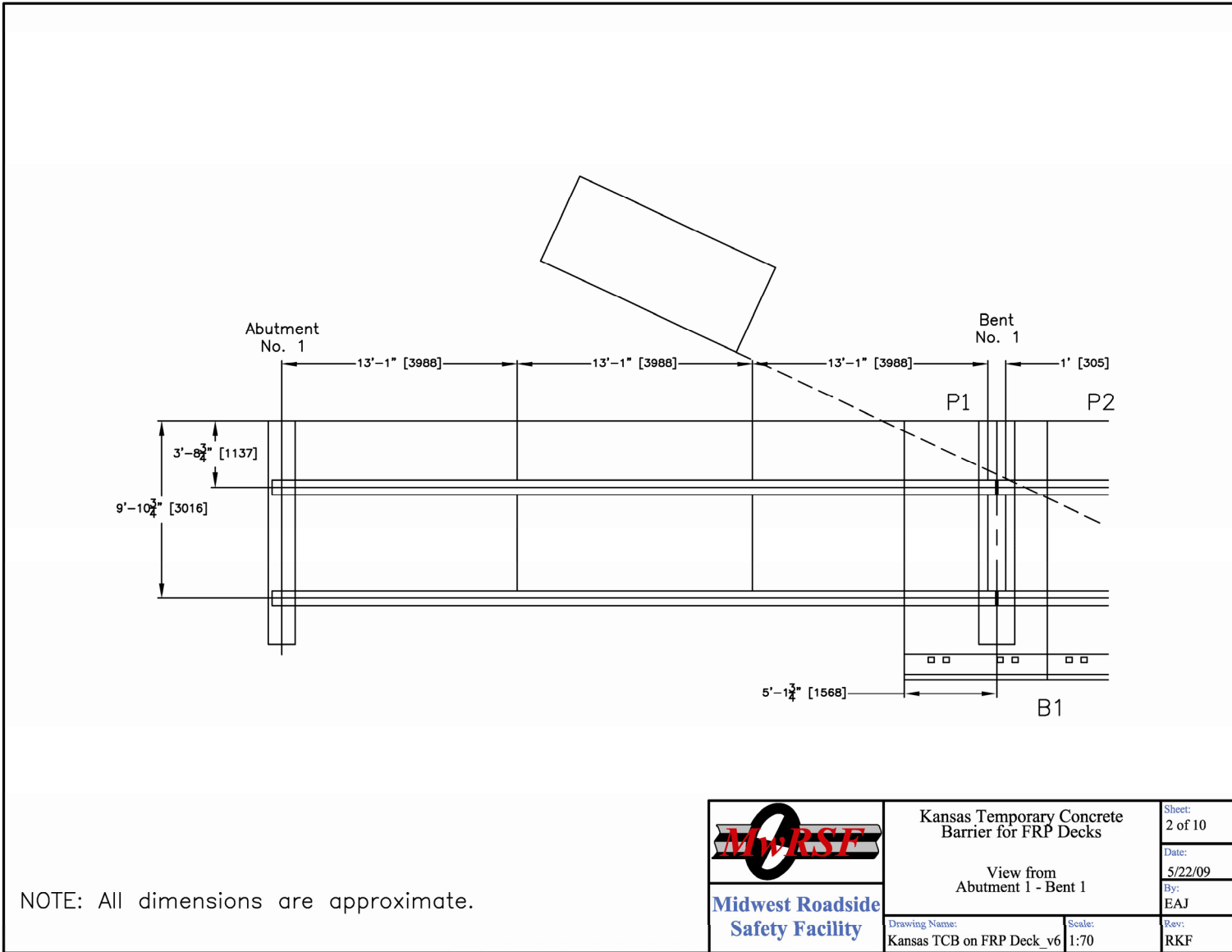

Figure 2. Test Installation Layout, Test No. KSFRP-1

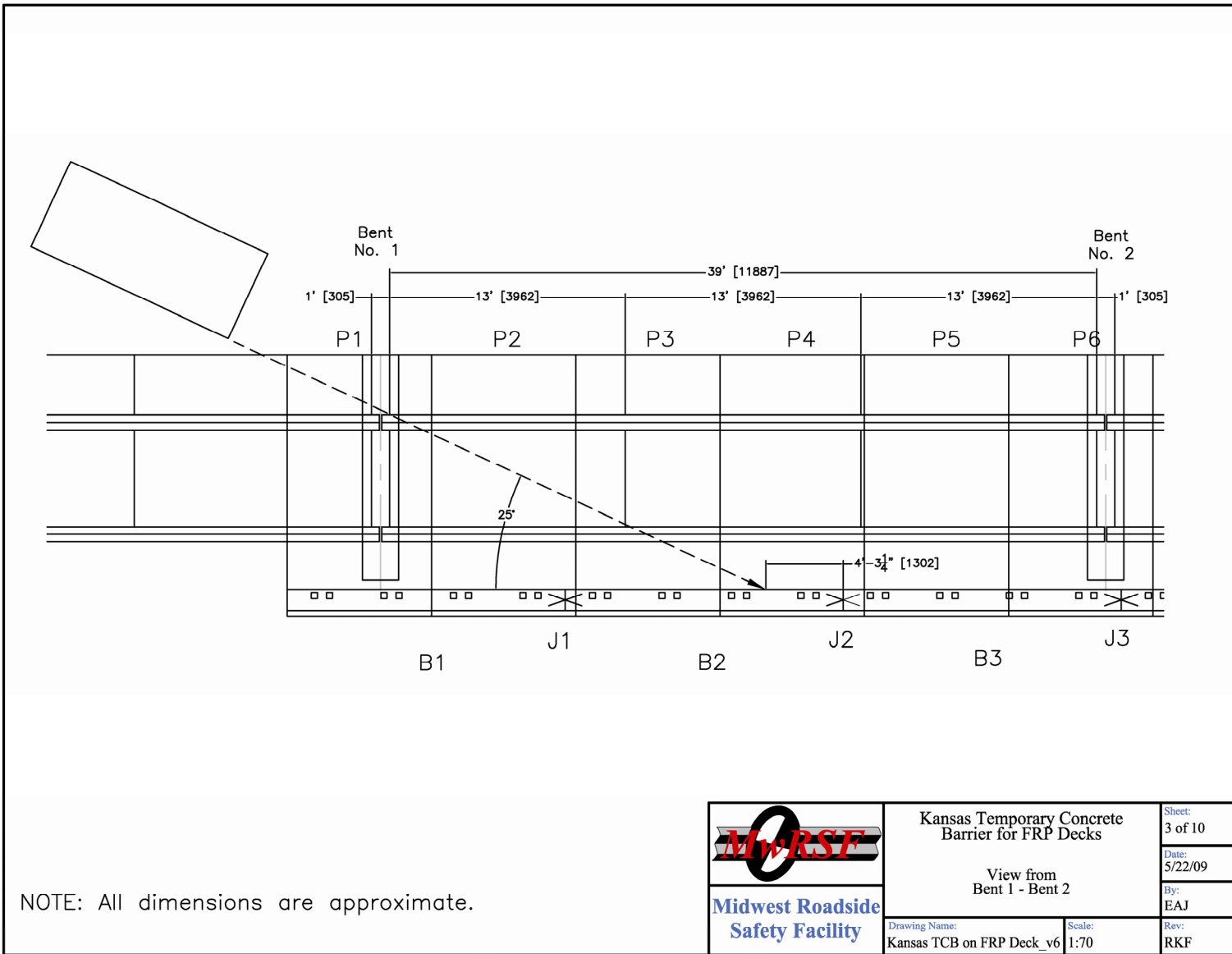
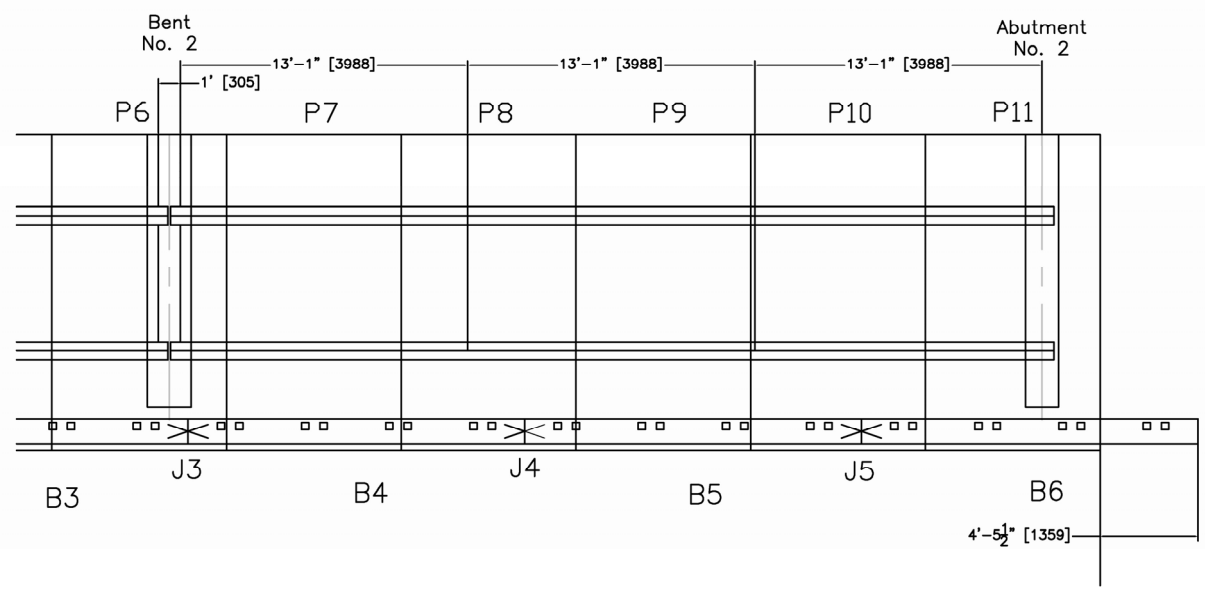

Figure 3. Test Installation Layout, Test No. KSFRP-1

10



NOTE: All dimensions are approximate.

	Kansas Temporary Concrete Barrier for FRP Decks View from Bent 2 - Abutment 2		Sheet: 4 of 10
	Drawing Name: Kansas TCB on FRP Deck_v6		Date: 5/22/09
Scale: 1:70		By: EAJ	
		Rev: RKF	

Figure 4. Test Installation Layout, Test No. KSFRP-1

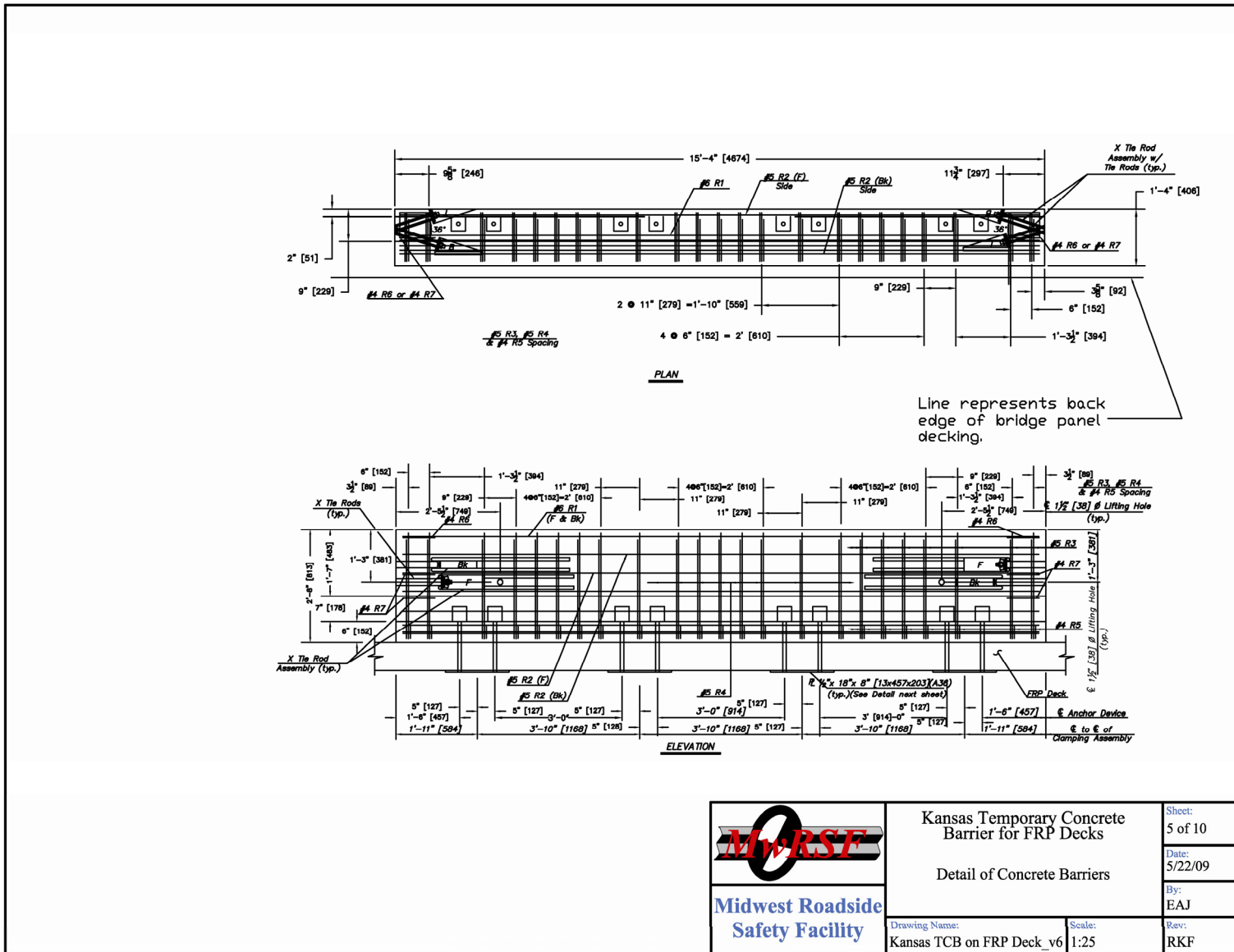

Figure 5. Concrete Barrier Details, Test No. KSFRP-1

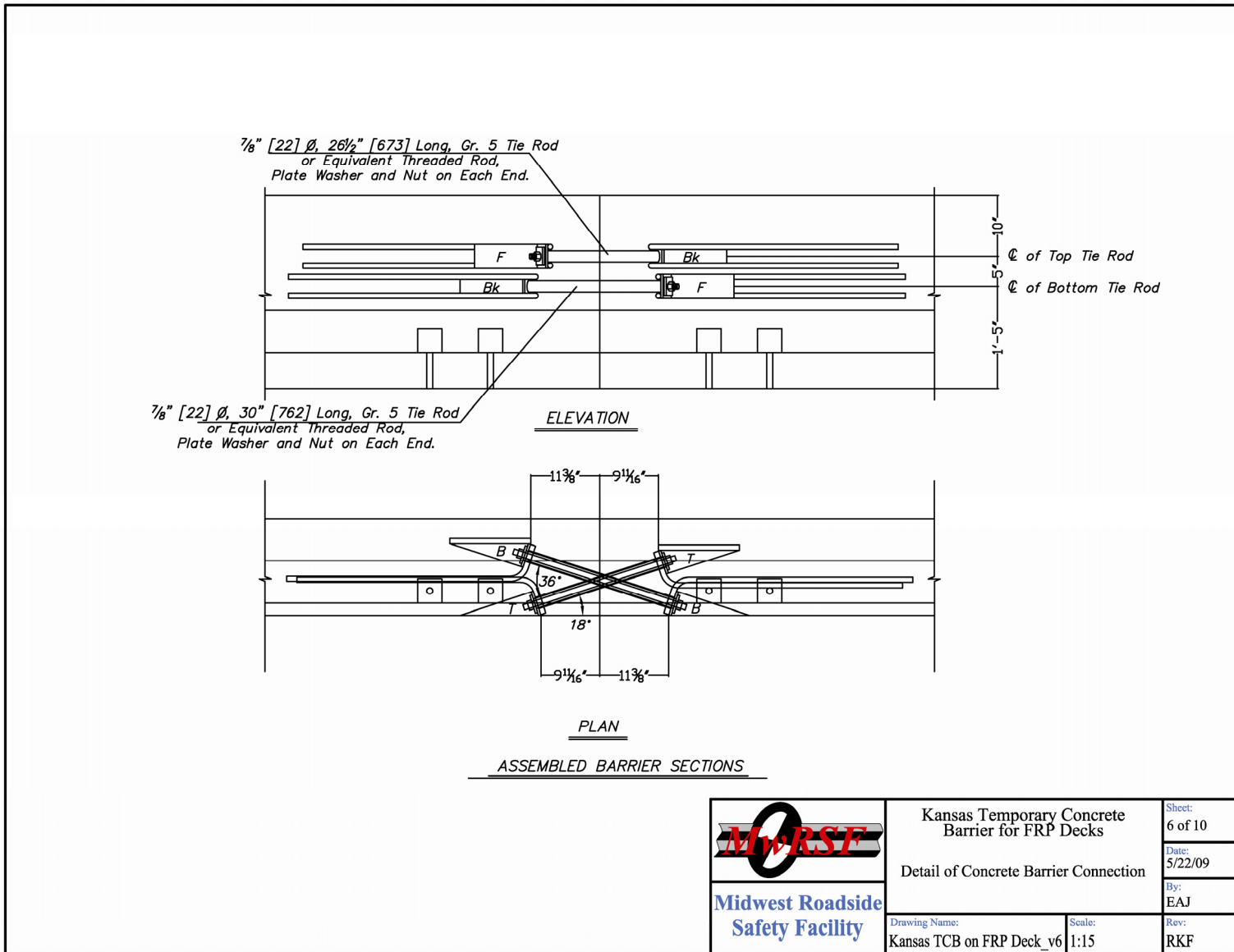
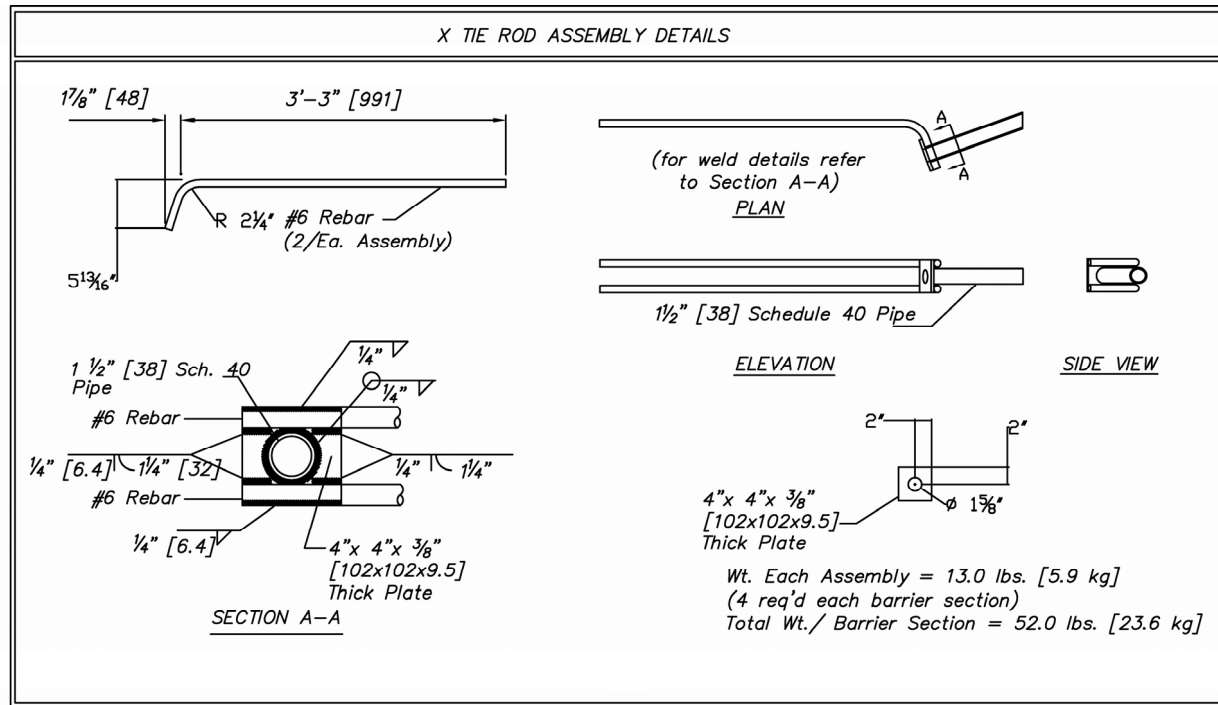

Figure 6. Concrete Barrier Connection Details, Test No. KSFRP-1



	Kansas Temporary Concrete Barrier for FRP Decks Connection Detail	Sheet: 7 of 10
	Drawing Name: Kansas TCB on FRP Deck_v6	Scale: 1:15
Midwest Roadside Safety Facility	By: EAJ	Rev: RKF

Figure 7. Concrete Barrier Connection Hardware Details, Test No. KSFRP-1

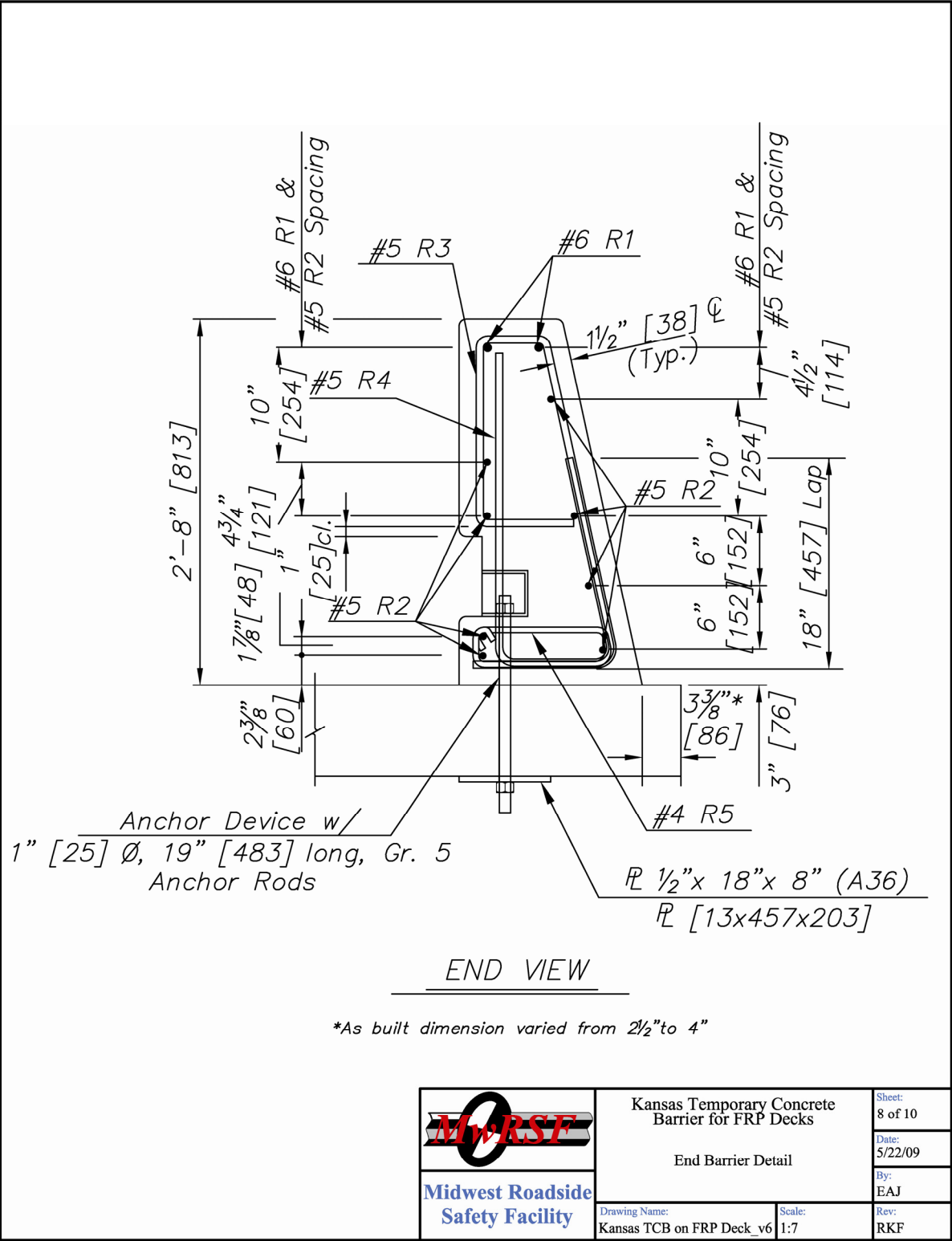
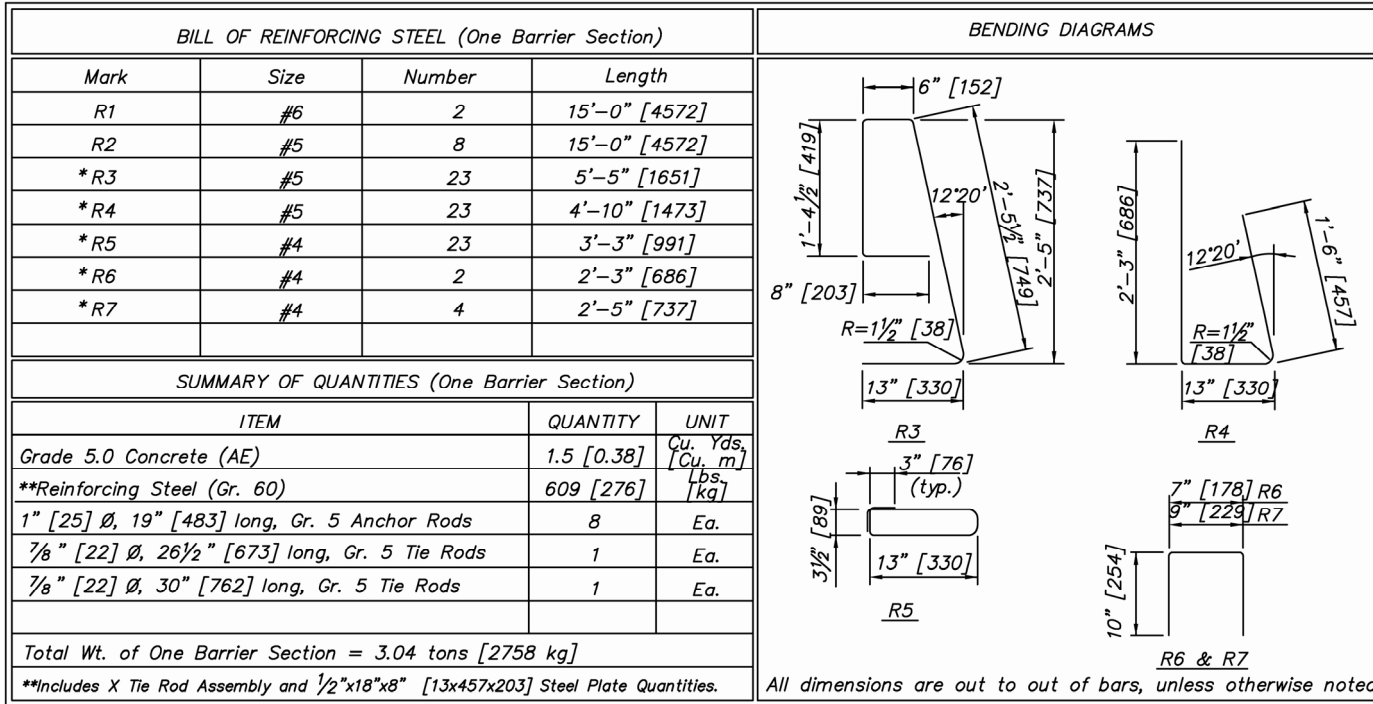

Figure 8. Concrete Barrier Reinforcement Details, Test No. KSFRP-1

* See bending Diagrams



	Kansas Temporary Concrete Barrier for FRP Decks	Sheet: 9 of 10
	Rebar Details	Date: 5/22/09
Drawing Name: Kansas TCB on FRP Deck_v6	Scale: 1:15	By: EAJ
		Rev: RKF

Figure 9. Reinforcement Specifications, Test No. KSFRP-1

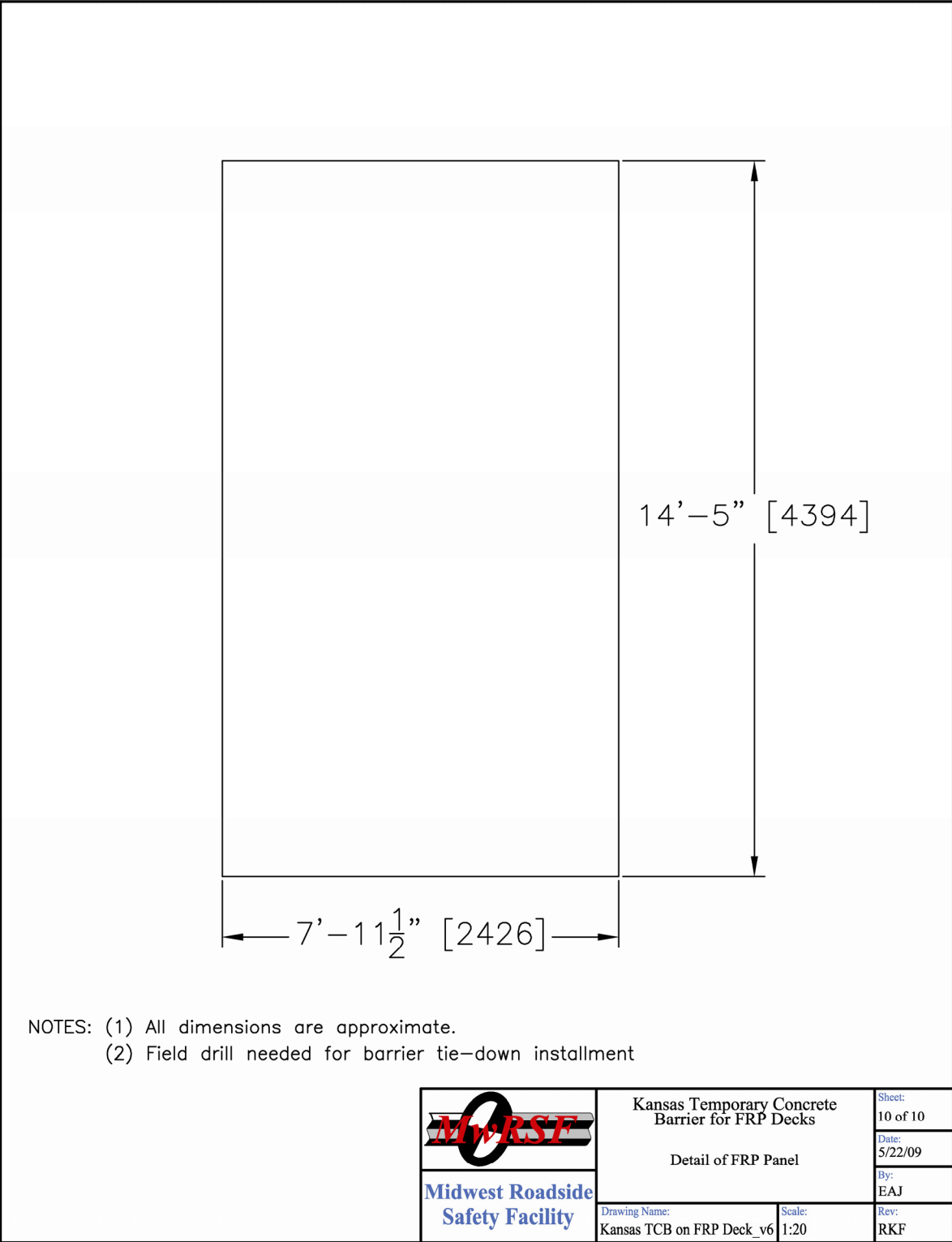
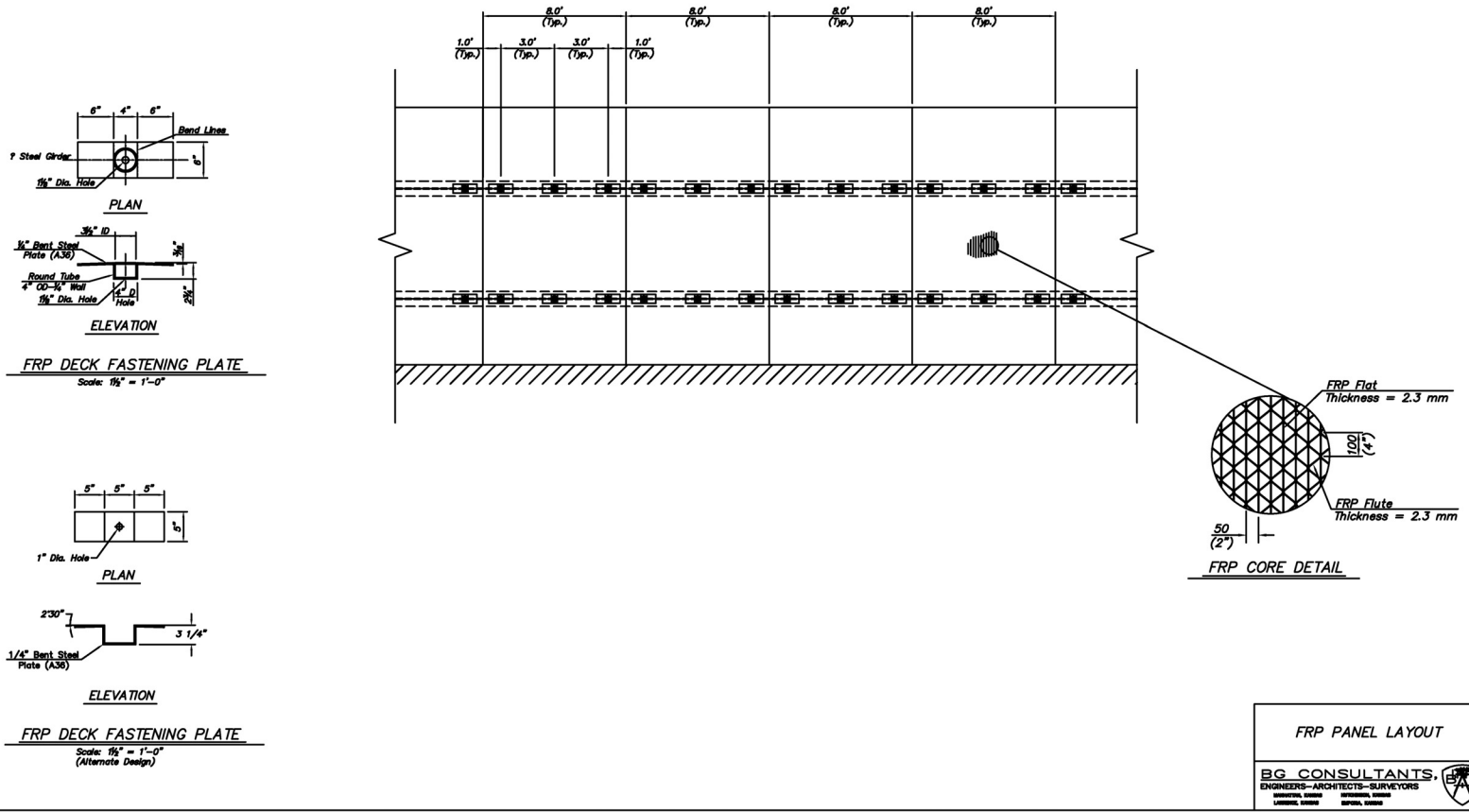

Figure 10. FRP Panel Details, Test No. KSFRP-1



17

Figure 11. FRP Details, Test No. KSFRP-1

FRP PANEL LAYOUT

BG CONSULTANTS
ENGINEERS—ARCHITECTS—SURVEYORS

GENERAL MANAGER	MANAGING DIRECTOR
ASSOCIATE MANAGER	ASSOCIATE MANAGER



Figure 12. Test Installation, Test No. KSFRP-1



Figure 13. Test Installation, Test No. KSFRP-1



Figure 14. Barrier System, Test No. KSFRP-1



Figure 15. Barrier Connection Joints, Test No. KSFRP-1



Figure 16. Barrier Anchorage System, Test No. KSFRP-1



Figure 17. Composite Deck Panel Connection, Test No. KSFRP-1

4 TEST REQUIREMENTS AND EVALUATION CRITERIA

4.1 Test Requirements

Longitudinal barriers, such as bridge rails attached to FRP bridge decks, must satisfy the impact safety standards provided in MASH (1) in order to be accepted by the Federal Highway Administration (FHWA) for use on National Highway System (NHS) new construction projects or as a replacement for existing designs not meeting current safety standards. According to TL-3 of MASH, longitudinal barrier systems must be subjected to two full-scale vehicle crash tests. The two full-scale crash tests are as follows:

1. Test Designation No. 3-10 consisted of a 2,425-lb (1,100-kg) passenger car impacting the system at a nominal speed and angle of 62 mph (100 km/h) and 25 degrees, respectively.
2. Test Designation No. 3-11 consisted of a 5,004-lb (2,270-kg) pickup truck impacting the system at a nominal speed and angle of 62 mph (100 km/h) and 25 degrees, respectively.

Over the years, several high-speed, small car crash tests have been successfully performed into both rigid and mostly rigid concrete barrier systems. Many of these barrier systems have been configured using a vertical front face, a safety shape, or single-slope geometries, while utilizing a 32-in. (813-mm) top barrier height. For these evaluations, limited or no barrier deflections were encountered when impacted by small passenger cars. Since the proposed test barrier is 32 in. (813 mm) tall and using a vertical front face, the small car crash test, test designation no. 3-10, was considered unnecessary for this project. The test conditions of TL-3 longitudinal barriers are summarized in Table 1.

Table 1. MASH TL-3 Crash Test Conditions

Test Article	Test Designation	Test Vehicle	Impact Conditions			Evaluation Criteria ¹
			Speed		Angle (deg.)	
			mph	km/h		
Longitudinal Barrier	3-10	1100C	62	100	25	A,D,F,H,I
	3-11	2270P	62	100	25	A,D,F,H,I

¹ Evaluation criteria explained in Table 2.

4.2 Evaluation Criteria

Evaluation criteria for full-scale vehicle crash testing are based on three appraisal areas: (1) structural adequacy; (2) occupant risk; and (3) vehicle trajectory after collision. Criteria for structural adequacy are intended to evaluate the ability of the bridge railing to contain and redirect impacting vehicles. Occupant risk evaluates the degree of hazard to occupants in the impacting vehicle. Vehicle trajectory after collision is a measure of the potential for the post-impact trajectory of the vehicle to become involved in secondary collisions with other vehicles or fixed objects, thereby increasing the risk of injury to the occupants of the impacting vehicle and/or other vehicles. These evaluation criteria are summarized in Table 2 and are defined in greater detail in MASH. The full-scale vehicle crash test was conducted and reported in accordance with the procedures provided in MASH.

Table 2. MASH Evaluation Criteria for Longitudinal Barriers

Structural Adequacy	A. Test article should contain and redirect the vehicle or bring the vehicle to a controlled stop; the vehicle should not penetrate, underride, or override the installation although controlled lateral deflection of the test article is acceptable.		
Occupant Risk	D. Detached elements, fragments or other debris from the test article should not penetrate or show potential for penetrating the occupant compartment, or present an undue hazard to other traffic, pedestrians, or personnel in a work zone. Deformations of, or intrusions into, the occupant compartment should not exceed limits set forth in Section 5.3 and Appendix E of MASH.		
	F. The vehicle should remain upright during and after collision. The maximum roll and pitch angles are not to exceed 75 degrees.		
	H. Occupant Impact Velocities (OIV) (see Appendix A, Section A5.3 of MASH for calculation procedure) should satisfy the following limits:		
	Occupant Impact Velocity Limits, ft/s (m/s)		
	Component	Preferred	Maximum
	Longitudinal and Lateral	30 ft/s (9.1 m/s)	40 ft/s (12.2 m/s)
I. The Occupant Ridedown Acceleration (ORA) (see Appendix A, Section A5.3 of MASH for calculation procedure) should satisfy the following limits:	Occupant Ridedown Acceleration Limits (g's)		
Component	Preferred	Maximum	
Longitudinal and Lateral	15.0 g's	20.49 g's	

5 TEST CONDITIONS

5.1 Test Facility

The testing facility is located at the Lincoln Air Park on the northwest side of the Lincoln Municipal Airport and is approximately 5 miles (8.0 km) northwest of the University of Nebraska-Lincoln.

5.2 Vehicle Tow and Guidance System

A reverse cable tow system with a 1:2 mechanical advantage was used to propel the test vehicle. The distance traveled and the speed of the tow vehicle were one-half that of the test vehicle. The test vehicle was released from the tow cable before impact with the barrier system. A digital speedometer on the tow vehicle increased the accuracy of the test vehicle impact speed.

A vehicle guidance system developed by Hinch (4) was used to steer the test vehicle. A guide-flag, attached to the left-front wheel and the guide cable, was sheared off before impact with the barrier system. The 0.375-in. (9.5-mm) diameter guide cable was tensioned to approximately 3,500 lbf (15.6 kN) and supported both laterally and vertically every 100 ft (30.48 m) by hinged stanchions. The hinged stanchions stood upright while holding up the guide cable, but as the vehicle was towed down the line, the guide-flag struck and knocked each stanchion to the ground. For test no. KSFRP-1 the vehicle guidance system was 1,069 ft (326 m) long.

5.3 Test Vehicles

For test no. KSFRP-1, a 2002 Dodge Ram 1500 Quad Cab pickup truck was used as the test vehicle. The curb, test inertial, and gross static vehicle weights were 5,106 lbs (2,316 kg), 5,009 lbs (2,272 kg), and 5,179 lbs (2,349 kg), respectively. The test vehicle is shown in Figure 18, and vehicle dimensions are shown in Figure 19.



Figure 18. Test Vehicle, Test No. KSFRP-1

Date: 3/13/2009 Test Number: KSFRP-1 Model: Ram 1500
Make: Dodge Vehicle I.D.#: 3D7HA18N02G130726
Tire Size: 265/70 R17 Year: 2002 Odometer: 72026
Tire Inflation Pressure: 35 psi
*(All Measurements Refer to Impacting Side)

Vehicle Geometry -- in. (mm)

a	<u>78 (1981)</u>	b	<u>74.375 (1889)</u>
c	<u>227.5 (5779)</u>	d	<u>48 (1219)</u>
e	<u>140.25 (3562)</u>	f	<u>39 (991)</u>
g	<u>28.03 (712)</u>	h	<u>62.08 (1577)</u>
i	<u>15.25 (387)</u>	j	<u>24.625 (625)</u>
k	<u>20.625 (524)</u>	l	<u>29.25 (743)</u>
m	<u>67.625 (1718)</u>	n	<u>67.5 (1715)</u>
o	<u>43 (1092)</u>	p	<u>4.75 (121)</u>
q	<u>30.875 (784)</u>	r	<u>18.5 (470)</u>
s	<u>15.25 (387)</u>	t	<u>75.5 (1918)</u>

Mass Distribution

Gross Static	LF <u>1443</u>	RF <u>1457</u>
	LR <u>1107</u>	RR <u>1172</u>

Weights lbs (kg)

	Curb	Test Inertial	Gross Static
W-front	<u>2876 (1305)</u>	<u>2794 (1267)</u>	<u>2900 (1315)</u>
W-rear	<u>2230 (1012)</u>	<u>2215 (1005)</u>	<u>2279 (1034)</u>
W-total	<u>5106 (2316)</u>	<u>5009 (2272)</u>	<u>5179 (2349)</u>

GVWR Ratings

Front	<u>3650</u>
Rear	<u>3900</u>
Total	<u>6650</u>

Dummy Data

Type: Hybrid 2
Mass: 170 lbs
Seat Position: Passenger

Engine Type: 8 cyl. Gas.
Engine Size: 4.7L
Transmission Type: Automatic Manual
FWD RWD 4WD

Note any damage prior to test: none

Figure 19. Vehicle Dimensions, Test No. KSFRP-1

The longitudinal component of the center of gravity (c.g.) was determined using the measured axle weights. The Suspension Method (5) was used to determine the vertical component of the c.g. for the pickup truck. This method is based on the principle that the c.g. of any freely suspended body is in the vertical plane through the point of suspension. The vehicle was suspended successively in three positions, and the respective planes containing the c.g. were established. The intersection of these planes pinpointed the c.g. location. The location of the final c.g. is shown in Figures 19 and 20. Data used to calculate the location of the c.g. is shown in Appendix B.

Square black and white-checkered targets were placed on the vehicle to aid in the analysis of the high-speed videos, as shown in Figure 20. Round, checkered targets were placed on the center of gravity on the left-side door, the right-side door, and the roof of the vehicle. The remaining targets were located for references so that they could be viewed from the high-speed cameras for video analysis.

The front wheels of the test vehicle were aligned for camber, caster, and toe-in values of zero so that the vehicles would track properly along the guide cable. A 5B flash bulb was mounted on the left-side of the vehicle's dash to pinpoint the time of impact with the barrier system on the high-speed videos. The flash bulb was fired by a pressure tape switch mounted at the impact corner of the bumper. A remote controlled brake system was installed in the test vehicle so the vehicle could be brought safely to a stop after the test.

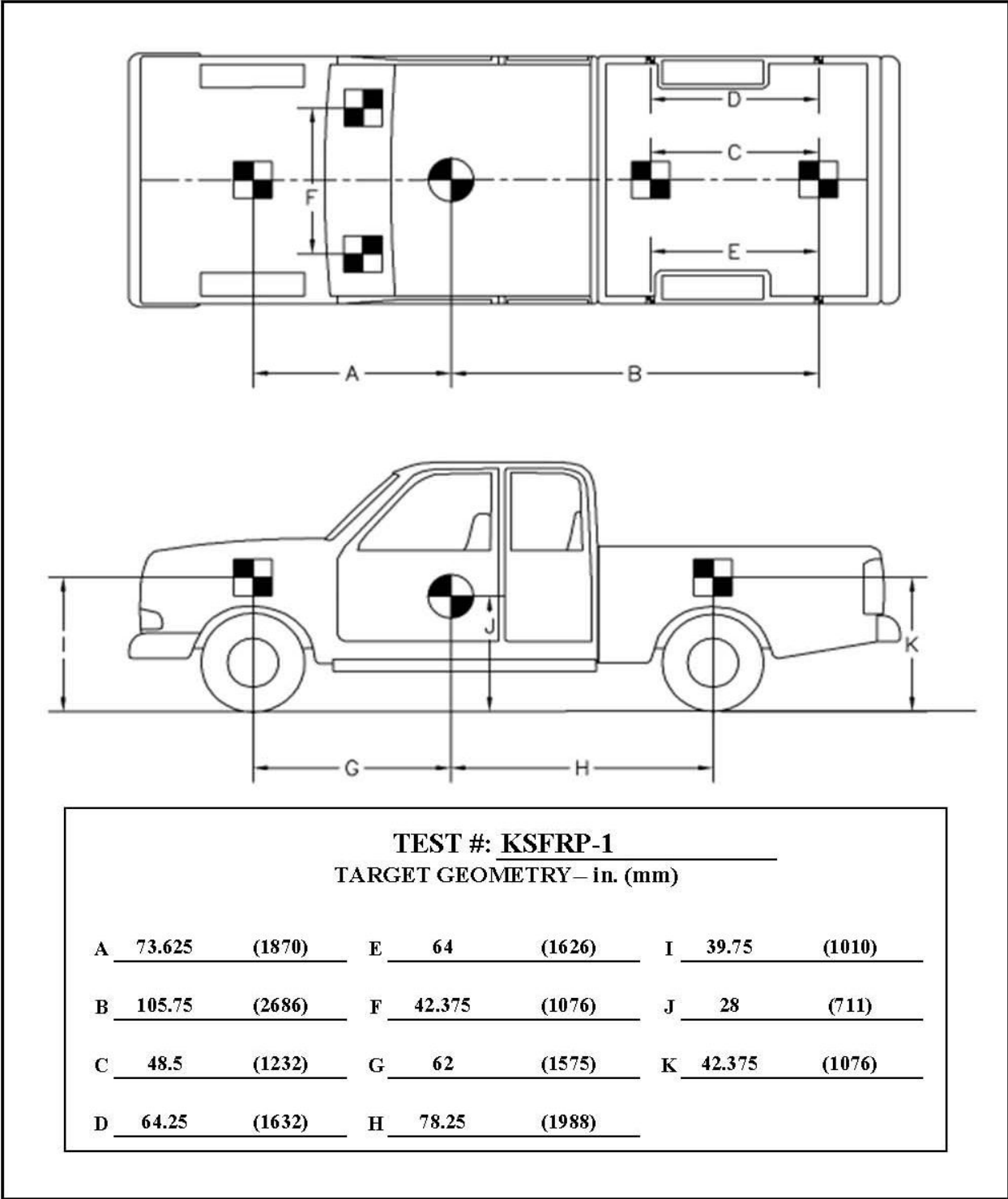

Figure 20. Target Geometry, Test No. KSFRP-1

5.4 Data Acquisition Systems

5.4.1 Accelerometers

Three environmental shock and vibration sensor/recorder systems were used to measure the accelerations in the longitudinal, lateral, and vertical directions. All of the accelerometers were mounted near the center of gravity of the test vehicle.

One triaxial piezoresistive accelerometer system, Model EDR-4 6DOF-500/1200, was developed by Instrumented Sensor Technology (IST) of Okemos, Michigan and includes three differential channels as well as three single-ended channels. The EDR-4 6DOF-500/1200 was configured with 24 MB of RAM memory, a range of ± 500 g's, a sample rate of 10,000 Hz, and a 1,677 Hz anti-aliasing filter. "EDR4COM" and "DynaMax Suite" computer software programs and a customized Microsoft Excel worksheet were used to analyze and plot the accelerometer data.

Another triaxial piezoresistive accelerometer system, Model EDR-3, was also developed by Instrumented Sensor Technology (IST) of Okemos, Michigan. The EDR-3 was configured with 256 kB of RAM memory, a range of ± 200 g's, a sample rate of 3,200 Hz, and a 1,120 Hz lowpass filter. "DynaMax 1 (DM-1)" and "DADiSP" computer software programs and a customized Microsoft Excel worksheet were used to analyze and plot the accelerometer data.

The third accelerometer system was a two-Arm piezoresistive accelerometer system developed by Endevco of San Juan Capistrano, California. Three accelerometers were used to measure each of the longitudinal, lateral, and vertical accelerations independently at a sample rate of 10,000 Hz. Data was collected using a Sensor Input Module (SIM), Model TDAS3-SIM-16M, which was developed by Diversified Technical Systems, Inc. (DTS) of Seal Beach, California. The SIM was configured with 16 MB SRAM memory and 8 sensor input channels

with 250 kB SRAM/channel. The SIM was mounted on a TDAS3-R4 module rack. The module rack was configured with isolated power/event/communications, 10BaseT Ethernet and RS232 communication, and an internal backup battery. Both the SIM and module rack are crashworthy. The “DTS TDAS Control” computer software program and a customized Microsoft Excel worksheet were used to analyze and plot the accelerometer data.

5.4.2 Rate Transducers

An Analog Systems 3-axis rate transducer with a range of 1,200 degrees/sec in each of the three directions (roll, pitch, and yaw) was used to measure the rates of motion of the test vehicle. The rate transducer was mounted inside the body of the EDR-4 6DOF-500/1200 and recorded data at 10,000 Hz to a second data acquisition board inside the EDR-4 6DOF-500/1200 housing. The raw data measurements were then downloaded, converted to the appropriate Euler angles for analysis, and plotted. “EDR4COM” and “DynaMax Suite” computer software programs and a customized Microsoft Excel spreadsheet were used to analyze and plot the rate transducer data.

An additional angle rate sensor, the ARS-1500, with a range of 1,500 degrees/sec in each of the three directions (roll, pitch, and yaw) was used to measure the rates of rotation of the test vehicles. The angular rate sensor was mounted on an aluminum block inside the test vehicle near the center of gravity and recorded data at 10,000 Hz to the SIM. The raw data measurements were then downloaded, converted to the proper Euler angles for analysis, and plotted. The “DTS TDAS Control” computer software program and a customized Microsoft Excel worksheet were used to analyze and plot the angular rate sensor data.

5.4.3 Pressure Tape Switches

For test no. KSFRP-1, five pressure-activated tape switches, spaced at 6.56 ft (2 m) intervals, were used to determine the speed of the vehicle before impact. Each tape switch fired a strobe light which sent an electronic timing signal to the data acquisition system as the right-front tire of the test vehicle passed over it. Test vehicle speeds were determined from electronic timing mark data recorded using TestPoint and LabVIEW computer software programs. Strobe lights and high-speed video analysis are used only as a backup in the event that vehicle speed cannot be determined from the electronic data.

5.4.4 High-Speed Photography

Two high-speed AOS VITcam digital video cameras, three high-speed AOS X-PRI digital video cameras, four JVC digital video cameras, and two Canon digital video cameras were utilized to film test no. KSFRP-1. A schematic of the camera locations along with the camera lens information and camera operating speed is shown in Figure 21. The high-speed videos were analyzed using ImageExpress MotionPlus software. Actual camera speed and camera divergence factors were considered in the analysis of the high-speed videos.

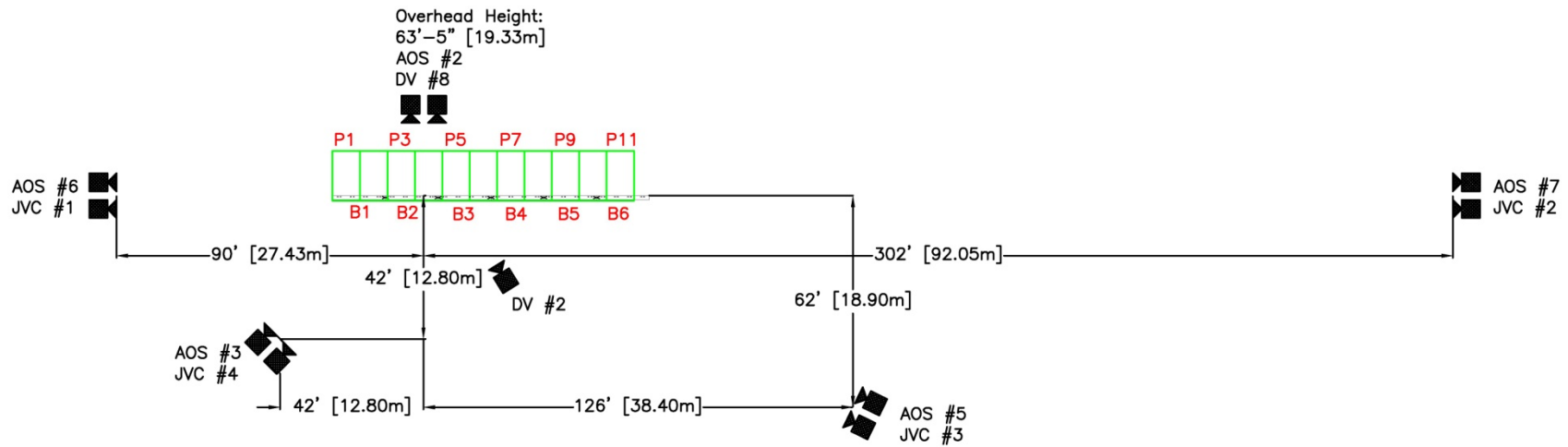

	No.	Type	Operating Speed (frames/sec)	Lens	Lens Setting
High-Speed Video	2	Vitcam CTM	500	Cosmicar 12.5 mm Fixed	-
	3	Vitcam CTM	500	Sigma 24-135 mm	135
	5	X-PRI	500	Sigma 24-70 mm	70
	6	X-PRI	500	Fujinon 50 mm Fixed	-
	7	X-PRI	500	Sigma 70-200 mm	135
Digital Video	1	JVC - GZ-MC500 (Everio)	29.97		
	2	JVC - GZ-MC40u (Everio)	29.97		
	3	JVC - GZ-MC40u (Everio)	29.97		
	4	JVC - GZ-MC40u (Everio)	29.97		
	2	Canon-ZR90	29.97	DOC #2	
	8	Canon-ZR90	29.97	DOC #1	

Figure 21. Camera Locations, Speeds, and Lens Settings, Test No. KSFRP-1

6 FULL SCALE CRASH TEST NO. KSFRP-1

6.1 Test No. KSFRP-1

The 5,179-lb (2,349-kg) pickup truck, with a simulated occupant in the front passenger's-side seat, impacted the bridge railing system at a speed of 61.1 mph (98.4 km/h) and at an angle of 25.8 degrees. A summary of the test results and sequential photographs are shown in Figure 22. Additional sequential photographs are shown in Figures 23 through 24. Documentary photographs of the crash test are shown in Figure 25.

6.2 Weather Conditions

Test no. KSFRP-1 was conducted on March 13, 2009 at approximately 1:00 pm. The weather conditions were reported as shown in Table 3.

Table 3. Weather Conditions, Test No. KSFRP-1

Temperature	45° F
Humidity	39%
Wind Speed	0 mph
Wind Direction	0° from True North
Sky Conditions	Sunny
Visibility	10 Statute Miles
Pavement Surface	Dry
Previous 3-Day Precipitation	0 in.
Previous 7-Day Precipitation	0.15 in.

6.3 Test Description

Initial vehicle impact was to occur 4 ft – 3¼ in. (1.30 m) upstream from the center of the joint between barrier nos. 2 and 3, as shown in Figure 26. Actual impact occurred at the targeted impact location. A sequential description of the impact events is provided in Table 4. The vehicle came to rest 195 ft – 7 in. (59.61 m) downstream from impact and 3 ft – 4 in. (1.02 m) laterally away from the traffic-side face of the barrier. The vehicle trajectory and final resting position are shown in Figures 22 and 27.

Table 4. Time-Sequential Description of Impact Events, Test No. KSFRP-1

TIME (sec)	EVENT
0	Right corner of the front bumper impacted barrier no. 2 at the impact location
0.006	Right-front quarter panel impacted the upper portion of barrier no. 2
0.020	Truck rolled toward the barrier
0.024	Right headlight shattered
0.032	The downstream end of barrier no. 2 deflected backward
0.036	The downstream end of barrier no. 1 began to deflect
0.038	The upstream end of barrier no. 3 began to deflect and rotate backward due to deflection of barrier no. 2
0.044	Front grill disengaged
0.046	FRP deck edge deflected vertically downward at the impact location
0.050	The back side of barrier no. 1 encountered concrete spalling at its downstream end, and the left-front tire became airborne
0.052	Truck began to yaw away from the barrier system
0.056	Right-front quarter panel protruded over the top of barrier no. 2 and the right-front wheel impacted barrier no. 3
0.058	Vehicle's front end pitched upward
0.076	Right-front corner of the right-side door contacted the joint between barrier nos. 2 and 3, causing concrete spalling on the upstream end of barrier no. 3
0.086	Concrete spalling on back side of barrier no. 3 near upstream end
0.100	The FRP deck edge rebounded upward
0.116	The upstream end of barrier no. 5 encountered concrete spalling near the top
0.120	Left-rear tire became airborne
0.186	Right-rear quarter panel contacted barrier no. 2 and vehicle became parallel to the system with a resultant velocity of 52.2 mph (84.0 km/h)
0.194	Right-front tire became airborne
0.198	FRP deck edge deflected downward
0.198	Vehicle's front end pitched downward
0.204	Right taillight disengaged
0.214	Right-rear tire became airborne
0.262	FRP deck edge rebounded upward
0.352	Truck exited the system with a resultant velocity of 48.9 mph (78.7 km/h) and at a trajectory angle of 5.2 degrees
0.446	Right-front tire contacted the ground
0.500	Vehicle's front end pitched upward
0.598	Maximum roll angle of 22.5 degrees
0.810	Right-rear tire contacted the ground
0.812	Left-front tire contacted the ground
0.876	Left-rear tire contacted the ground

6.4 System Damage

Damage to the barrier was minimal, as shown in Figures 28 through 32. Barrier damage consisted of contact marks on the front face of the concrete segments, spalling of the concrete, and concrete cracking and failure. The length of vehicle contact along the barrier was approximately 11 ft – 5 in. (3.48 m), which spanned from 5 ft – 5 in. (1.65 m) upstream from the center of the joint between barrier nos. 2 and 3 to 6 ft (1.83 m) downstream from the center of the joint between barrier nos. 2 and 3.

Tire marks were visible on the front face of barrier nos. 2 and 3. Scuff marks were also found on the front and top faces of barrier nos. 2 and 3. The upper-rear corner at the downstream end of barrier no. 1 was fractured. Concrete spalling and cracking occurred at the downstream end of barrier no. 2 and upstream end of barrier no. 3. A 3-in. x 6-in. x 4½-in. (76-mm x 152-mm x 114-mm) piece of concrete was removed from the top corner of the downstream end of barrier no. 2. A 4½-in. x 8-in. x 10-in. (114-mm x 203-mm x 254-mm) piece of concrete was removed from the top-upstream corner of barrier no. 3. Another piece of concrete was fractured just below the removed corner of barrier no. 3, but it remained attached to the barrier. Concrete spalling occurred along the upper and lower edges of the shelf as well as around the edges of the threaded rod insets at the downstream end of barrier no. 2. Concrete spalling also occurred on the vertical face of the joint between barrier nos. 2 and 3.

A small gouge and crack were found 34 in. (864 mm) upstream from the downstream end of barrier no. 2 at its base. A larger gouge and crack were found 13 in. (330 mm) upstream from the downstream end of barrier no. 2 at its base. Small gouges and scratches were located across the front faces of barrier nos. 2 and 3. A 21-in. (533-mm) long crack was found at the base of barrier no. 3 starting 7 in. (178 mm) downstream from the upstream end of the barrier. A vertical

crack was found 18½ in. (470 mm) downstream from the upstream end of barrier no. 3 at its base. A vertical crack was also found at the base of barrier no. 3 near its center.

No failure was observed in the FRP composite deck panels or at any of the anchor locations. Panel nos. 3 through 6 were laterally displaced, with panel no. 5 having a maximum displacement of ½ in. (13 mm), as shown in Figure 31.

The permanent set of the barrier system was ⅞ in. (22 mm), including a combination of barrier and deck panel shift, which occurred at the downstream end of barrier no. 2, as measured in the field. The maximum lateral dynamic barrier deflection, including tipping of the barrier along the top surface, was 4.4 in. (112 mm) at the downstream end of barrier no. 2, as determined from high-speed video analysis. The working width of the system was found to be 20.4 in. (518 mm).

6.5 Vehicle Damage

Damage to the vehicle was moderate, as shown in Figures 33 through 36. Minimal occupant compartment deformations occurred to the right-side floor pan. A maximum lateral deflection of ¾ in. (19 mm) was located near the right front of the right-side floor pan. Maximum vertical deflections of ½ in. (13 mm) were found near the left side of the right-side floor pan. Maximum longitudinal deflections of ¾ in. (19 mm) were found near the center of the right-side floor pan. Complete occupant compartment and vehicle deformations and the corresponding locations are provided in Appendix C.

The majority of the damage was concentrated on the right-front corner and right side of the vehicle where the impact occurred. The right side of the bumper was crushed inward and back. The right-front fender was pushed upward near the door panel and was dented and torn behind the right-front wheel. The right-front steel rim was severely deformed with tears and

significant crushing. The right upper control arm was fractured. The right-front tire was torn and deformed. The grill was fractured around the right-side headlight assembly. The right-side headlight and fog lamp were removed from the vehicle. The right side of the radiator was pushed backward. Denting and scraping were observed on the entire right side. The right-front door was ajar, and creases were found in the door's sheet metal. The right-rear door was dented and was ajar approximately 4 in. (102 mm). The right-rear wheel assembly was deformed inward. The right-rear steel rim was crushed, and scuff marks were found on the tire. The tailgate was released from the hinges. The right taillight was removed. The right side of the rear bumper was dented and scuffed. The left side of the front bumper was deformed downward 2 in. (51 mm). The front of the hood had a 2-in. (51-mm) gap on the left side. The left-front fender was dented in at the top and back. There was a 2-in. (51-mm) gap between the left-front fender and the left-front door. The right side of the windshield had a hairline crack, and the lower-left side encountered minor cracking. The roof and remaining window glass remained undamaged.

6.6 Occupant Risk

The calculated occupant impact velocities (OIVs) and maximum 0.010-sec average occupant ridedown accelerations (ORAs) in both the longitudinal and lateral directions are shown in

Table 5. It is noted that the OIVs and ORAs were within the suggested limits provided in MASH. The calculated THIV and PHD values are also shown in

Table 5. The results of the occupant risk analysis, as determined from the accelerometer data, are summarized in Figure 22. The recorded data from the accelerometers and the rate transducers are shown graphically in Appendix D.

The longitudinal and lateral vehicle accelerations, as measured at the vehicle's center of mass, were also processed using a 50-msec moving average. The 50-msec moving average vehicle accelerations were then combined with the uncoupled yaw angle versus time data in order to estimate the vehicular loading applied to the concrete barrier system. From the data analysis, the perpendicular and parallel impact forces were determined, as provided in Figure 37. For test no. KSFRP-1 and using the EDR-4 data recorder, the maximum perpendicular or lateral load imparted to the barrier was 338,282 N (76,049 lbs).

Table 5. Summary of OIV, ORA, THIV, and PHD Values, Test No. KSFRP-1

Evaluation Criteria		Transducer		
		EDR-3	EDR-4	DTS
OIV ft/s (m/s)	Longitudinal	-18.38 (-5.60)	-17.25 (-5.26)	-17.86 (-5.45)
	Lateral	-26.09 (-7.95)	-24.88 (-7.58)	-25.22 (-7.69)
ORA g's	Longitudinal	6.34	5.93	6.51
	Lateral	-5.40	-5.81	-6.34
THIV ft/s (m/s)		-	28.41 (8.66)	29.36 (8.95)
PHD g's		-	7.53	8.37

6.7 Discussion

The analysis of the test results for test no. KSFRP-1 showed that the bridge railing system adequately contained and redirected the 2270P vehicle with controlled lateral displacements of the barrier. No detached elements or fragments showed the potential for penetrating the occupant compartment nor presented undue hazard to other traffic. Deformations of, or intrusions into, the occupant compartment that could have caused serious injury did not occur. The test vehicle did not penetrate nor ride over the barrier and remained upright during and after the collision.

Vehicle roll, pitch, and yaw angular displacements were noted, as shown in Appendix D, and were deemed acceptable because they did not adversely influence occupant risk safety criteria nor cause rollover. After impact, the vehicle exited the barrier at an angle of 5.2 degrees, and its trajectory did not violate the bounds of the exit box. Therefore, test no. KSFRP-1 (test designation no. 3-11) was determined to be acceptable according safety performance criteria provided in MASH.

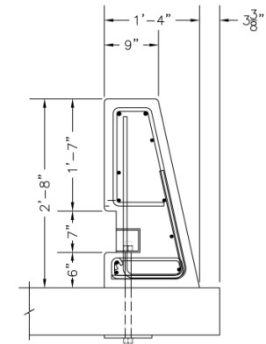
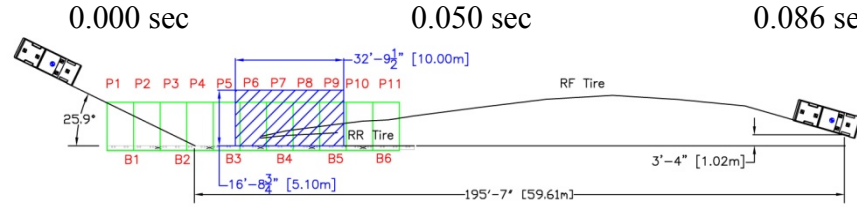
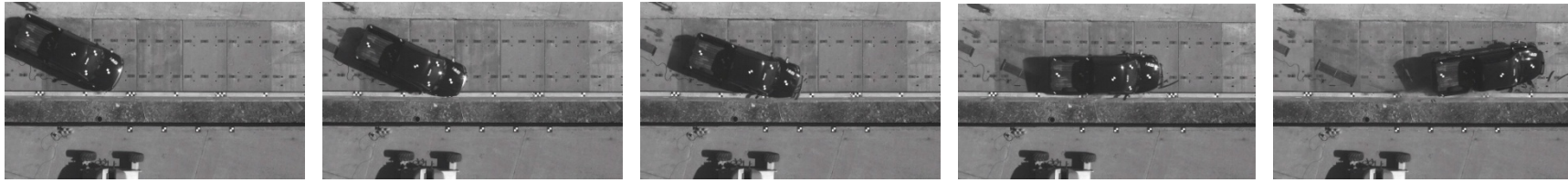

• Test Agency	MwRSF
• Test Number	KSFRP-1
• Date	3/13/09
• MASH Test Designation	3-11
• Test Article	Temporary Concrete Barrier on FRP Composite Bridge Deck
• Total Length	92 ft (28.04 m)
• Key Component – Concrete Barrier Segment	
Description	Vertical Face
Length	15 ft – 4 in. (4.67 m)
Height	32 in. (813 mm)
Base Width	16 in. (406 mm)
Top Width	9 in. (229 mm)
• Key Component – Anchors	
Diameter	1 in. (25 mm)
Material	Grade 5 Anchor Rod
Number per Barrier	8
• Key Component – Washer Plate	
Dimension	18 in. x 8 in. x 1/2 in. (457 mm x 203 mm x 13 mm)
Material	ASTM A36 Steel
• Vehicle Model	2002 Dodge Ram 1500 Quad Cab Pickup
Curb	5,106 lbs (2,316 kg)
Test Inertial	5,009 lbs (2,272 kg)
Gross Static	5,179 lbs (2,349 kg)
• Impact Conditions	
Speed	61.1 mph (98.3 km/h)
Angle	25.9 deg
Impact Location	4 ft – 3 1/4 in. upstream of barrier nos. 2 and 3 joint
• Exit Conditions	
Speed	48.9 mph (78.7 km/h)
Angle	5.2 deg
• Vehicle Stability	Satisfactory
• Vehicle Stopping Distance	195 ft – 7 in. (59.61 m) downstream 3 ft – 4 in. (1.02 m) from traffic-side face
• Occupant Ridedown Acceleration (DTS)	
Longitudinal	6.51 g's < 20.49 g's
Lateral	-6.34 g's < 20.49 g's
• Occupant Impact Velocity (DTS)	
Longitudinal	-17.86 ft/s (-5.45 m/s) < 40 ft/s (12.2 m/s)
Lateral	-25.22 ft/s (-7.69 m/s) < 40 ft/s (12.2 m/s)

• Occupant Ridedown Acceleration (EDR-4)	
Longitudinal	5.93 g's < 20.49 g's
Lateral	-5.81 g's < 20.49 g's
• Occupant Impact Velocity (EDR-4)	
Longitudinal	-17.25 ft/s (-5.26 m/s) < 40 ft/s (12.2 m/s)
Lateral	-24.88 ft/s (-7.58 m/s) < 40 ft/s (12.2 m/s)
• Occupant Ridedown Acceleration (EDR-3)	
Longitudinal	6.34 g's < 20.49 g's
Lateral	-5.40 g's < 20.49 g's
• Occupant Impact Velocity (EDR-3)	
Longitudinal	-18.38 ft/s (-5.60 m/s) < 40 ft/s (12.2 m/s)
Lateral	-26.09 ft/s (-7.95 m/s) < 40 ft/s (12.2 m/s)
• THIV (DTS – not required)	29.36 ft/s (8.95 m/s)
• PHD (DTS – not required)	8.37 g's
• THIV (EDR-4 – not required)	28.41 ft/s (8.66 m/s)
• PHD (EDR-4 – not required)	7.53 g's
• Maximum Angular Displacements (DTS)	
Roll	22.5 deg
Pitch	-4.5 deg
Yaw	-42.7 deg
• Maximum Angular Displacements (EDR-4)	
Roll	21.9 deg
Pitch	-2.7 deg
Yaw	-41.9 deg
• Vehicle Damage	Moderate
VDS ^(a)	1-RFQ-3
CDC ⁽²⁾	01-RDEW3
Maximum Interior Deformation	1 in. (25 mm)
• Test Article Damage	Minor
• Test Article Deflections	
Permanent Set	7/8 in. (22 mm)
Dynamic	4.4 in. (112 mm)
Working Width	20.4 in. (518 mm)

Figure 22. Summary of Test Results and Sequential Photographs, Test No. KSFRP-1

43



0.000 sec



0.080 sec



0.148 sec



0.260 sec



0.594 sec



0.810 sec



0.000 sec



0.112 sec



0.194 sec



0.446 sec

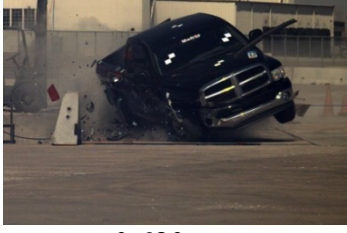

0.680 sec

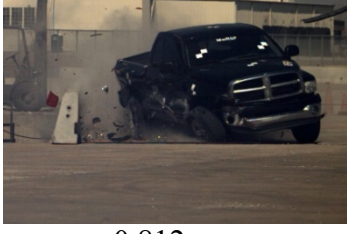

0.812 sec

Figure 23. Additional Sequential Photographs, Test No. KSFRP-1



0.000 sec



0.024 sec



0.046 sec



0.076 sec

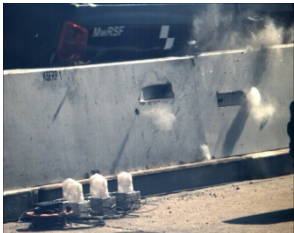

0.204 sec



0.262 sec



0.000 sec



0.058 sec



0.116 sec



0.186 sec



0.352 sec



0.456 sec

Figure 24. Additional Sequential Photographs, Test No. KSFRP-1



Figure 25. Documentary Photographs, Test No. KSFRP-1



Figure 26. Impact Location, Test No. KSFRP-1



Figure 27. Vehicle's Final Position and Trajectory Marks, Test No. KSFRP-1



Figure 28. System Damage, Test No. KSFRP-1

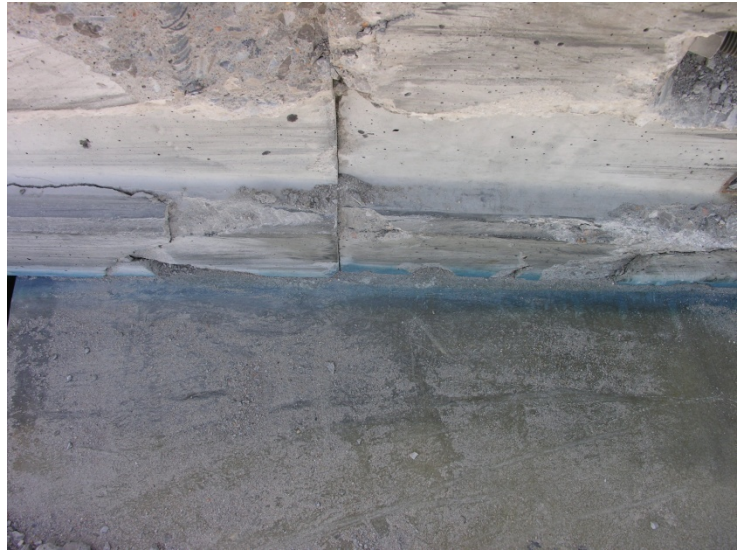

50

Figure 29. Barrier No. 2 Damage, Test No. KSFRP-1



Figure 30. Joint Damage Between Barrier Nos. 2 and 3, Test No. KSFRP-1



Figure 31. Panel Shift - Joints 3 and 4 (Top) and 4 and 5 (Bottom), Test No. KSFRP-1



Figure 32. Panel Joints 2 and 3 (Top) and 4 and 5 (Bottom) Damage, Test No. KSFRP-1



Figure 33. Vehicle Damage, Test No. KSFRP-1



Figure 34. Vehicle Damage, Test No. KSFRP-1



Figure 35. Vehicle Damage, Test No. KSFRP-1



Figure 36. Interior Occupant Compartment Deformation, Test No. KSFRP-1

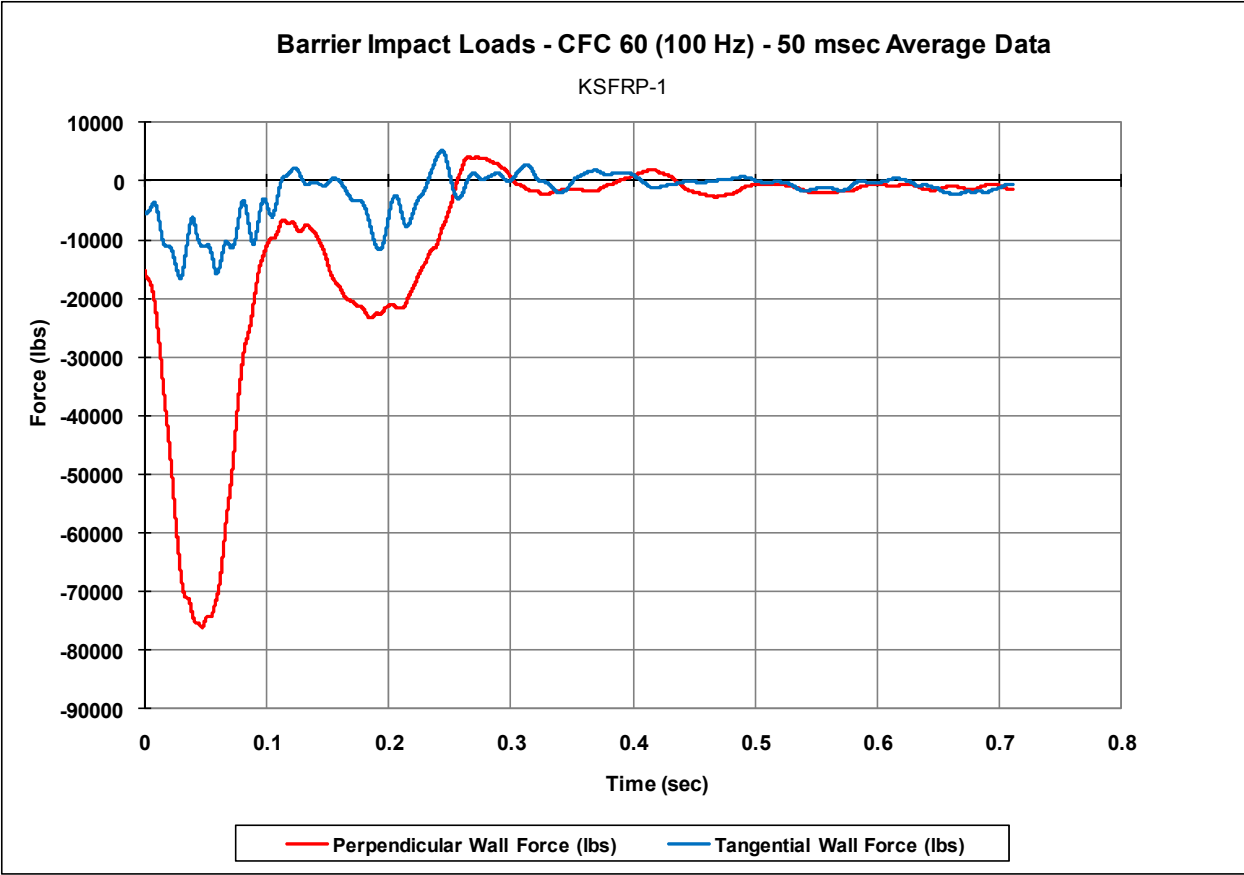

Figure 37. Impact Forces Imparted to the Barrier System, Test No. KSFRP-1

7 SUMMARY, CONCLUSIONS, AND RECOMMENDATIONS

A vertical-faced, precast concrete barrier system was developed for use with FRP composite panel bridge decks. Each barrier segment was fastened to the FRP deck panels using eight 1-in. (25-mm) diameter Grade 5 anchor rods. An 18-in. long x 8-in. wide x ½-in. thick (457-mm x 203-mm x 13-mm) ASTM A36 steel plate washer was located between the bottom of the deck and the hex nuts at each set of two anchor rod positions. The back side of the barriers was placed 3⅜ in. (86 mm) from the back edge of the FRP bridge deck panels. An X-joint, tie rod assembly was used to connect the ends of adjoining barriers together. One full-scale vehicle crash test (test designation no. 3-11) was performed on the bridge railing system according to the TL-3 safety performance criteria presented in MASH. A summary of the safety performance evaluation is provided in Table 6.

The full-scale crash test, test no. KSFRP-1, was conducted with a 5,179-lb (2,349-kg) pickup truck impacting 4 ft – ¾ in. (1.30 m) upstream from the downstream end of barrier no. 2 at a speed of 61.1 mph (98.4 km/h) and at an angle of 25.8 degrees. The vehicle was safely redirected and did not show potential to override the barrier nor cause vehicle instability. Although this system was not crash tested with a small car according to test designation 3-10, MwRSF researchers believe that vertical-face barrier system would have performed in satisfactory manner. As a result, the vertical-faced bridge railing system attached to an FRP composite panel bridge deck system was determined to be acceptable according to the TL-3 safety performance criteria presented in MASH.

Table 6. Summary of Safety Performance Evaluation Results

Evaluation Factors	Evaluation Criteria			Test No. KSFRP-1	
Structural Adequacy	A.	Test article should contain and redirect the vehicle or bring the vehicle to a controlled stop; the vehicle should not penetrate, underride, or override the installation although controlled lateral deflection of the test article is acceptable.		S	
Occupant Risk	D.	Detached elements, fragments or other debris from the test article should not penetrate or show potential for penetrating the occupant compartment, or present an undue hazard to other traffic, pedestrians, or personnel in a work zone. Deformations of, or intrusions into, the occupant compartment should not exceed limits set forth in Section 5.3 and Appendix E of MASH 08.		S	
	F.	The vehicle should remain upright during and after collision. The maximum roll and pitch angles are not to exceed 75 degrees.		S	
	H.	Occupant Impact Velocities (OIV) (see Appendix A, Section A5.3 of MASH for calculation procedure) should satisfy the following limits:		S	
		Occupant Impact Velocity Limits, ft/s (m/s)			
		Component	Preferred		Maximum
Longitudinal and Lateral	30 ft/s (9.1 m/s)	40 ft/s (12.2 m/s)			
I.	The Occupant Ridedown Acceleration (ORA) (see Appendix A, Section A5.3 of MASH for calculation procedure) should satisfy the following limits:		S		
	Occupant Ridedown Acceleration Limits (g's)				
	Component	Preferred		Maximum	
Longitudinal and Lateral	15.0 g's	20.49 g's			

S – Satisfactory
 NA - Not Applicable

U – Unsatisfactory

8 REFERENCES

1. Sicking, D.L., Mak, K.K., Rohde, J.R., and Reid, J.D., *Manual for Assessing Safety Hardware – Draft Report*, Submitted to National Cooperative Highway Research Program (NCHRP), Project 22-14(2) Panel, Prepared by the Midwest Roadside Safety Facility, University of Nebraska-Lincoln, 2008.
2. Stolle, C.S., Polivka, K.A., Faller, R.K., Rohde, J.R., Sicking, D.L., *Evaluation of a New Jersey Safety Shape, Segmented Concrete Barrier for Use on Composite Panel Bridge Decks*, Final Report to the Kansas Department of Transportation, Transportation Research Report No. TRP-03-181-07, Midwest Roadside Safety Facility, University of Nebraska – Lincoln, June 5, 2007.
3. Ross, H.E., Sicking, D.L., Zimmer, R.A., and Michie, J.D., *Recommended Procedures for the Safety Performance Evaluation of Highway Features*, National Cooperative Highway Research Program (NCHRP) Report No. 350, Transportation Research Board, Washington, D.C., 1993.
4. Hinch, J., Yang, T.L., and Owings, R., *Guidance Systems for Vehicle Testing*, ENSCO, Inc., Springfield, VA, 1986.
5. *Center of Gravity Test Code - SAE J874 March 1981*, SAE Handbook Vol. 4, Society of Automotive Engineers, Inc., Warrendale, Pennsylvania, 1986.
6. *Vehicle Damage Scale for Traffic Investigators*, Second Edition, Technical Bulletin No. 1, Traffic Accident Data (TAD) Project, National Safety Council, Chicago, Illinois, 1971
7. *Collision Deformation Classification – Recommended Practice J224 March 1980*, Handbook Volume 4, Society of Automotive Engineers (SAE), Warrendale, Pennsylvania, 1985.

9 APPENDICES

Appendix A. Material Specifications

PRESTRESSED CONCRETE, INC.

P.O. BOX 311 • 2800 N. OLD HIGHWAY 81 • NEWTON, KANSAS 67114

Date: 3-26-09

KDOT TEST BARRIERS

PROJECT NAME

TO: MIDWEST ROADSIDE SAFETY FACILITY
UNIVERSITY OF NEBRASKA - LINCOLN
527 NEBRASKA HALL
LINCOLN, NEBRASKA 68588-0529
ATTENTION: RONALD K. FALLER, P.D. PE.

PROJECT NUMBER

19-07 (719)

KDOT "D" NUMBER

PCI JOB NUMBER

CONTRACT NUMBER

LINE NUMBER

ITEM NUMBER

Dear Sir,

This is to certify that the material listed below is required for the referenced project and meets or exceeds all requirements of the Kansas Department of Transportation Standard Specifications and Provisions for the said project.

ASSEMBLY DESCRIPTION: BARRIER

<u>PAGE</u>	<u>MANUFACTURER</u>	<u>MATERIAL DESCRIPTION/SIZE</u>	<u>HEAT NO.</u>
<u>1-2</u>	<u>DOLESE</u>	<u>LS4 ROCK</u>	
<u>3</u>	<u>LAFARGE</u>	<u>MAI SAND</u>	
<u>4-6</u>	<u>ASH GROVE</u>	<u>TYPE III CEMENT</u>	
<u>7-8</u>	<u>GRACE</u>	<u>ADD MIXTURES</u>	
<u>9</u>	<u>DETAIL</u>		

<u>CAST DATE</u>	<u>RELEASE</u>	<u>28 DAY STRENGTH (PSI)</u>
<u>6-26-2007</u>	<u>4297</u>	<u>8236 7998</u>
<u>6-28</u>	<u>4377</u>	<u>7082 7838</u>
<u>6-29</u>	<u>4615</u>	<u>7600 7321</u>
<u>7-2</u>	<u>4934</u>	<u>8037 7878</u>
<u>7-3</u>	<u>3860</u>	<u>6088 6127</u>
<u>7-5</u>	<u>4615</u>	<u>6605 6446</u>
<u>AVG.</u>	<u>4450</u>	<u>7271</u>

PRESTRESSED CONCRETE, INC.

SUBSCRIBED AND SWORN TO BEFORE ME,

THIS DAY OF MARCH 26 A.D. 2009

Rawena D. Schroeder

MY TERM EXPIRES AUGUST 2, 2009

BY: Ray Collier

Ray Collier
Quality Control Manager
Prestressed Concrete, Inc.

Figure A-1. Barrier Materials

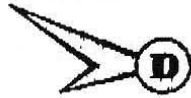

A SYMBOL OF QUALITY
A SYMBOL OF SERVICE

DOLESE

PHONE (405) 235-2311 • 20 N.W. 13th • P.O. BOX 677 • OKLAHOMA CITY, OK 73101-0677
December 2008.
08-TRP-253

Prestressed Concrete, Inc.
Attention: Ray
Hwy. 81 N. & 27
Newton, KS 67114

FAX TO 316-283-2321
ATTENTION: RAY

Gentlemen:

To comply with your request, the following data is submitted for the coarse aggregate material which we propose to furnish for the subject project.

Source: Dolese Bros. Co., Richards Spur, Oklahoma				
<i>Physical Properties:</i>	<i>L.A. Abrasion:</i>	27.6%	<i>Na₂SO₄ Soundness:</i>	3.0%
	<i>Specific Gravity:</i>	2.69	<i>MgSO₄ Soundness:</i>	3.4%
	<i>Absorption:</i>	0.5%		
<i>Designation:</i>	1" #67 Washed		Slave Size	Percent Passing
<i>Specification:</i>	American Society for Testing and Materials (ASTM) C-33; American Association of State Highway & Transportation Officials (AASHTO) M-80		1"	100
			3/4"	90 - 100
			3/8"	20 - 55
			# 4	0 - 10
			# 8	0 - 5
			#200	0 - 1.5

Sincerely,
DOLESE BROS. CO.

Thomas R. Palone
Concrete/Materials Specialist

Figure A-2. Barrier Aggregate Specifications



A SYMBOL OF QUALITY
A SYMBOL OF SERVICE

DOLESE

PHONE (405) 235-2311 • 20 N W 13th • P O BOX 677 • OKLAHOMA CITY, OK 73101-0677

RICHARDS SPUR 1" #67 SPECIAL WASHED

DATE	1"	3/4"	1/2"	3/8"	#4	#8	#200
2007							
1/03/07	100	95	58	28	2	1	0.3
2/28/07	100	98	70	48	3	2	0.3
3/12/07	100	95	57	32	2	1	0.4
4/12/07	100	91	45	20	2	1	0.4
5/16/07	100	91	47	21	1	1	0.6
6/03/07	100	98	62	34	3	1	0.4
7/28/07	100	93	51	29	3	1	0.4
8/10/07	100	98	62	35	3	1	0.4
9/27/2007	100	99	60	28	7	2	0.4
10/11/2007	100	99	53	21	3	1	0.4
11/01/2007	100	99	68	32	7	1	0.4
12/01/2007	100	99	67	31	6	1	0.4
2008							
1/08	100	99	68	32	7	1	0.4
2/08	100	99	68	32	7	1	0.4
3/08	100	91	43	22	3	1	0.2
4/08	100	98	50	26	2	1	0.4
5/08	100	97	51	27	2	1	0.4
6/08	100	97	54	25	3	1	0.4
7/08	100	98	55	26	4	1	0.4
8/08	100	99	63	40	5	1	0.5
9/2008	100	92	45	25	3	1	0.5
10/2008	100	93	59	43	5	1	0.4
11/2008	100	92	58	43	4	1	0.4
12/2008	100	93	46	22	7	1	0.4
% Passing	100	90-100	-----	20-55	0-10	0-5	0-2

Figure A-3. Barrier Aggregate Specifications

LAFARGE AGGREGATES SAND TEST REPORT

PROJECT # MISC.

CONTRACTOR: PRESTRESSED CONCRETE, INC.

TYPE OF SAND: T-MA-1

DATE	TESTED BY	TONS	PILE INSP.	1/2"	3/8" 0-2	#4 6-33	#8 13-51	#16 28-64	#30 67-77	#50 87-93	#100 95-100	#200	GF 3.15-3.53	TONS ACC	TONS REJ
01-12-09	M.Rhoads	500	OK		0.8	9.1	25.6	49	71	91.5	98.8		3.45	500	
12-30-08	M.Rhoads	500	OK		0.9	9.6	24.9	50.7	73.7	92	98.8		3.50	500	
12-10-08	M.Rhoads	500	OK		0.4	8.5	26.7	50.4	71.1	90.6	98.7		3.46	500	
12-2-08	M.Rhoads	500	OK		0.1	5.8	22.2	45.2	68.8	91.4	99		3.33	500	
11-17-08	M.Rhoads	500	OK		0	6.2	20.9	44.5	67.8	90.6	98.8		3.29	500	
11-04-08	M.Rhoads	500	OK		2	9.9	28.8	51.8	72.4	91.5	98.7		3.55	500	
10-07-08	M.Rhoads	500	OK		1.1	9.2	27.5	50.6	71.2	90.8	98.5		3.49	500	
09-26-08	M.Rhoads	500	OK		1.5	8.5	25.6	49.4	70.1	90.7	98.7		3.45	500	
09-05-08	M.Rhoads	500	OK		0.5	9.2	25.3	46.5	69	89.9	98.5		3.41	500	
08-13-08	M.Rhoads	500	OK		2	8.3	19.7	41	68.7	88.7	98		3.22	500	
08-05-08	M.Rhoads	500	OK			7.4	16.6	41.1	67	91	98.5		3.22	500	
07-24-08	M.Rhoads	500	OK		0.7	7.2	18.7	42.2	66.7	90	98.2		3.24	500	
07-10-08	M.Rhoads	500	OK		1	7.1	19.1	41	65	89.8	98.4		3.21	500	
06-26-08	M.Rhoads	500	OK		0.6	6.8	19.9	44.3	67.8	90.4	98.7		3.29	500	
06-16-08	M.Rhoads	500	OK		0.6	7.7	23.3	44.5	70.3	88.7	98.3		3.29	500	
06-11-08	M.Rhoads	500	OK		1	8	23	45	70	89	98		3.29	500	
06-02-08	M.Rhoads	500	OK		0.8	8	24	46	68	90	99		3.36	500	
06-02-08	M.Rhoads	500	OK			7	23	47	70	91	99		3.37	500	
06-02-08	M.Rhoads	250	OK		0.3	8	22	46	68	90	99		3.33	250	
05-29-08	M.Rhoads	250	OK		0.3	6	23	49	74	94	99		3.45	250	
05-07-08	M.Rhoads	500	OK		1	6	22	46	69	91	99		3.34	500	
04-29-08	M.Rhoads	500	OK		0	4	20	48	74	93	99		3.38	500	
04-03-08	M.Rhoads	250	OK		0.6	7	23	46	71	92	100		3.38	250	
03-07-08	Doug	500	OK		0.7	6	22	46	69	91	99		3.33	500	
02-11-08	Doug	500	OK		0.2	7	25	50	73	92	99		3.47	500	
02-11-08	Doug	500	OK		0.2	7	23	48	71	91	99		3.38	500	
09-27-07	Doug	500	OK		1	7	22	46	69	91	99		3.34	500	
09-27-07	Doug	100	OK		1	6	21	45	69	91	99		3.31	100	
09-14-07	Doug	500	OK		Tr	6	21	46	69	90	99		3.31	500	
08-04-07	Lab	500	OK		1	7	23	47	71	90	99		3.38	500	
08-04-07	Lab	500	OK		1	7	23	47	71	90	99		3.38	500	
06-25-07	Doug	250	OK		1	7	21	42	67	90	99		3.27	250	
06-22-07	Doug	500	OK		1	7	23	47	68	90	99		3.35	500	
05-12-07	Doug	250	OK		1	8	26	46	74	93	99		3.47	250	
05-03-07	Doug	250	OK		Tr	7	22	43	68	90	98		3.31	250	
04-12-07	Doug	250	OK		1	7	21	42	67	90	99		3.27	250	
03-05-07	Doug	250	OK		1	9	23	49	72	92	99		3.46	250	
02-26-07	Doug	500	OK		1	8	24	51	72	92	100		3.47	500	
01-10-07	Doug	250	OK		Tr	8	24	49	68	87	98		3.34	250	

67

Figure A-4. Barrier Aggregate Specifications

ASH GROVE CEMENT COMPANY

ASH GROVE CEMENT COMPANY



Lot Number: 2178
 Quantity (tons): 28.39
 Trailer/Car: PE 5 129
 Shipped: 6/20/11
 Consigned to: Prestress Newton Ks

1801 North Santa Fe
 Post Office Box 519
 Chanute, Kansas 66720
 Phone: 620-431-4599
 Fax: 620-431-4552

Silo 34
 Cement Type: III

Production Period: March 4 - March 31, 2007 Date: 4/20/2007

STANDARD REQUIREMENTS
 ASTM C150

CHEMICAL			PHYSICAL			
Item	Spec. Limit	Test Result	Item	Spec. Limit	Test Result	
SiO ₂ (%)	A	21.07	Air content of mortar (volume %)	12 max	6.9	
Al ₂ O ₃ (%)	A	4.27	Fineness (cm ² /g)			
Fe ₂ O ₃ (%)	A	3.29	(Air permeability)	A	6650	
CaO (%)	A	63.41	Autoclave expansion (%)	0.80 max	0.00	
MgO (%)	5.0 max	2.00	Compressive strength (psi)	Min:		
SO ₃ (%)	3.5 max	3.23		1 Day	1740	4400
Loss on ignition (%)	3.0 max	1.60		3 Days	3480	5500
Na ₂ O (%)	A	0.18		7 Days	A	6220
K ₂ O (%)	A	0.48		28 Days	D	7580
Insoluble Residue (%)	0.75 max	0.29	Time of setting (minutes)	(Vicat)		
CO ₂ Content (%)		N/A		Initial	Not less than 45	82
LS Content (Calculated %)	3.0 max	N/A	Final	Not more than 375	195	
Potential compounds (%)			Specific Gravity		3.15	
C ₃ S	A	55				
C ₂ S	A	19				
C ₃ A	A	6				
C ₄ AF	A	10				
C ₄ AF+2(C ₃ A)	A	22				

OPTIONAL REQUIREMENTS
 ASTM C150 Tables 2 and 4

CHEMICAL			PHYSICAL		
Item	Spec. Limit	Test Result	Item	Spec. Limit	Test Result
C ₃ S + C ₃ A (%)	A		False set (%)	A	84.8
Equivalent alkalis (%)	0.60	0.50	Heat of hydration (kJ/kg)		
A = Not applicable.			7 days	A	A
B = Limit not specified by purchaser, test result provided for information only.			Compressive strength (Mpa)		
C = Test results for this period not available.				28 Days	A
D = Previous month's average value.					

We certify that the above described cement, at the time of shipment, meets the chemical and physical requirement of the ASTM C150-04 and AASHTO M85, or (other) _____ specification.

Signature: Marc D. Melton
 Marc D. Melton
 Title: Chief Chemist

Figure A-5. Cement Specifications

ASH GROVE CEMENT COMPANY

ASH GROVE CEMENT COMPANY



Lot Number: 2193
Quantity (tons): 27,93
Trailer/Car: 133
Shipped: 6-27-07
Consigned to: Prestress
Newton Ks

1801 North Santa Fe
Post Office Box 519
Chanute, Kansas 66720
Phone: 620-431-4500
Fax: 620-431-4552

Silo 34
Cement Type: III

Production Period: May 1 - May 29, 2007

Date: 6/15/2007

STANDARD REQUIREMENTS
ASTM C150

CHEMICAL		
Item	Spec. Limit	Test Result
SiO ₂ (%)	A	21.08
Al ₂ O ₃ (%)	A	4.31
Fe ₂ O ₃ (%)	A	3.26
CaO (%)	A	62.96
MgO (%)	6.0 max	1.99
SO ₃ (%)	3.5 max	3.18
Loss on ignition (%)	3.0 max	1.54
Na ₂ O (%)	A	0.21
K ₂ O (%)	A	0.47
Insoluble Residue (%)	0.75 max	0.39
CO ₂ Content (%)		0.41
LS Content (Calculated %)	3.0 max	1.05
Potential compounds (%)		
C ₃ S	A	54
C ₂ S	A	20
C ₃ A	A	6
C ₄ AF	A	10
C ₄ AF+2(C ₃ A)	A	22

PHYSICAL		
Item	Spec. Limit	Test Result
Air content of mortar (volume %)	12 max	6.7
Fineness (cm ² /g)		
(Air permeability)	A	6640
Autoclave expansion (%)	0.80 max	0.00
Compressive strength (psi)	Min:	
1 Day	1740	4240
3 Days	3480	5360
7 Days	A	6080
28 Days	D	7220
Time of setting (minutes)	(Vicat)	
Initial	Not less	88
Final	than 45	203
Final	Not more	203
Final	than 375	
Specific Gravity		3.15

OPTIONAL REQUIREMENTS
ASTM C150 Tables 2 and 4

CHEMICAL		
Item	Spec. Limit	Test Result
C ₃ S + C ₃ A (%)	A	
Equivalent alkalis (%)	0.60	0.52

PHYSICAL		
Item	Spec. Limit	Test Result
False set (%)	A	80.1
Heat of hydration (kJ/kg)		
7 days	A	A
Compressive strength (Mpa)		
28 Days	A	

A = Not applicable.
B = Limit not specified by purchaser, test result provided for information only.
C = Test results for this period not available.
D = Previous month's average value.

We certify that the above described cement, at the time of shipment, meets the chemical and physical requirement of the ASTM C150-04 and AASHTO M85, or (other) _____ specification.

Signature: Marc D. Melton
Title: Chief Chemist

Figure A-6. Cement Specifications

ASH GROVE CEMENT COMPANY

ASH GROVE CEMENT COMPANY



Lot Number: 2193
Quantity (tons): 28.42
Trailer/Car: 127
Shipped: 7-9-07

1801 North Santa Fe
Post Office Box 519
Chanute, Kansas 66720
Phone: 620-431-4500
Fax: 620-431-4552

Consigned to: Prostress
Netwon, KS

Silo 34
Cement Type: III

Production Period: May 1 - May 29, 2007 Date: 6/15/2007

STANDARD REQUIREMENTS
ASTM C150

CHEMICAL			PHYSICAL		
Item	Spec. Limit	Test Result	Item	Spec. Limit	Test Result
SiO ₂ (%)	A	21.08	Air content of mortar (volume %)	12 max	6.7
Al ₂ O ₃ (%)	A	4.31	Fineness (cm ² /g)		
Fe ₂ O ₃ (%)	A	3.26	(Air permeability)	A	6640
CaO (%)	A	62.96	Autoclave expansion (%)	0.80 max	0.00
MgO (%)	6.0 max	1.99	Compressive strength (psi)	Min:	
SO ₃ (%)	3.5 max	3.18	1 Day	1740	4240
Loss on ignition (%)	3.0 max	1.54	3 Days	3480	5360
Na ₂ O (%)	A	0.21	7 Days	A	6080
K ₂ O (%)	A	0.47	28 Days	D	7220
Insoluble Residue (%)	0.75 max	0.39	Time of setting (minutes)		
CO ₂ Content (%)		0.41	(Vicat)		
LS Content (Calculated %)	3.0 max	1.05	Initial	Not less than 45	88
Potential compounds (%)			Final	Not more than 375	203
C ₃ S	A	54	Specific Gravity		3.15
C ₂ S	A	20			
C ₃ A	A	6			
C ₄ AF	A	10			
C ₄ AF+2(C ₃ A)	A	22			

OPTIONAL REQUIREMENTS
ASTM C150 Tables 2 and 4

CHEMICAL			PHYSICAL		
Item	Spec. Limit	Test Result	Item	Spec. Limit	Test Result
C ₃ S + C ₃ A (%)	A		False set (%)	A	80.1
Equivalent alkalis (%)	0.60	0.52	Heat of hydration (kJ/kg)		
A = Not applicable.			7 days	A	A
B = Limit not specified by purchaser; test result provided for information only.			Compressive strength (Mpa)		
C = Test results for this period not available.			28 Days	A	
D = Previous month's average value.					

We certify that the above described cement, at the time of shipment, meets the chemical and physical requirement of the ASTM C150-04 and AASHTO M85, or (other) _____ specification.

Signature: Marc D. Melton
Title: Chief Chemist

Figure A-7. Cement Specifications

GRACE

Grace Construction Products

W.R. Grace & Co.-Conn.
4323 Crites Street
P.O. Box 2585-77252
Houston, TX 77003

713-223-8353
<http://www.gcp-grace.com>

September 28, 2006.

Prestressed Concrete Inc.
PO Box 311
Newton, KS 67114

Reference: Delivery D000642101 on 7/12/06 for 152 gal

To Whom It May Concern:

This is to certify that **DARAVAIR® 1000**, an air-entraining admixture, as manufactured and supplied by Grace Construction Products, W. R. Grace & Co.-Conn., is formulated to comply with the Specification for Air-Entraining Admixtures for Concrete, ASTM: C 260 (AASHTO M 154).

DARAVAIR® 1000 does not contain calcium chloride or chloride containing compounds as a functional ingredient. Chloride ions may be present in trace amounts contributed from the process water used in the manufacturing.

Materials supplied for the above referenced project is identical in all respects, including concentration, to the one originally submitted to and approved by the State of Kansas, Department of Transportation.

The foregoing is in addition to and not in substitution for our standard Conditions of Sale printed on the reverse side hereof.

Sincerely,

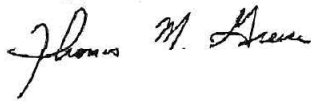

Thomas M. Greene
Technical Services



Figure A-8. Cement Specifications

Appendix B. Vehicle Center of Gravity Determination

KSFRP-1		Vehicle: 2002 Dodge Ram 1500QC				
Vehicle CG Determination						
VEHICLE	Equipment	Weight	Long CG	Vert CG	HOR M	Vert M
+	Unbalasted Truck(Curb)	5106	61.2626	28.14532	312806.9	143710
+	Brake receivers/wires	5	106	50	530	250
+	Brake Frame	6	36	27	216	162
+	Brake Cylinder (Nitrogen)	27	71	27	1917	729
+	Strobe/Brake Battery	6	67	29	402	174
+	Hub	27	0	14.75	0	398.25
+	CG Plate (EDRs)	8	54	32	432	256
-	Battery	-48	-7	44	336	-2112
-	Oil	-10	8	17	-80	-170
-	Interior	-72	50	24	-3600	-1728
-	Fuel	-157	113	20	-17741	-3140
-	Coolant	-22	-18	35	396	-770
-	Washer fluid	-6	-15	35	90	-210
BALLAST	Water	130	113	20	14690	2600
	Misc.				0	0
	Misc.				0	0
TOTAL WEIGHT		5000			310394.9	140149.3
					62.07897	28.02985

wheel base	140.25	Calculated Test Inertial Weight		
	NCHRP 350 Targets	Targets	CURRENT	Difference
	Test Inertial Weight	5000	5000	0.0
	Long CG	62	62.08	0.07897
	Vert CG	28	28.03	0.02985

Note, Long. CG is measured from front axle of test vehicle

Curb Weight		
	Left	Right
Front	1474	1402
Rear	1096	1134
FRONT	2876	
REAR	2230	
TOTAL	5106	

Actual test inertial weight (from scales)		
	Left	Right
Front	1434	1360
Rear	1082	1133
FRONT	2794	
REAR	2215	
TOTAL	5009	

Figure B-1. Vehicle Mass Distribution, Test No. KSFRP-1

Appendix C. Vehicle Deformation Records

VEHICLE PRE/POST CRUSH INFO

TEST: KSFRP-1
VEHICLE: Dodge Ram 1500

POINT	X	Y	Z	X'	Y'	Z'	DEL X	DEL Y	DEL Z
1	23	10	-0.25	23	10	-0.25	0	0	0
2	24.75	14.5	-2	24.75	14.5	-2	0	0	0
3	29.75	20	-4.5	29.75	20	-4.5	0	0	0
4	28.75	27.75	-2.25	28.75	27.25	-2.25	0	-0.5	0
5	18.5	7	-1.5	18.5	6.75	-1.5	0	-0.25	0
6	19.25	10	-2.5	19	10	-2.5	-0.25	0	0
7	20.25	13.5	-4.5	20.25	13.25	-4.5	0	-0.25	0
8	23.25	19.5	-7.5	23.25	19.25	-8	0	-0.25	-0.5
9	23.25	24.5	-7.5	23.25	24.5	-8	0	0	-0.5
10	23.25	29	-7.5	23.25	29	-8	0	0	-0.5
11	12.5	6.25	-2.25	12.5	6.25	-2.25	0	0	0
12	14.75	10	-5.25	14.75	10	-5.5	0	0	-0.25
13	16.25	12.75	-8.5	16.25	12.5	-8.75	0	-0.25	-0.25
14	16.5	19.75	-9	16.5	19.75	-9.25	0	0	-0.25
15	16.5	24.5	-9	16.5	24.75	-9.5	0	0.25	-0.5
16	16.5	29	-9.25	16.5	29.25	-9.75	0	0.25	-0.5
17	8	7	-2.5	8	7	-2.5	0	0	0
18	10.5	10.5	-8.25	10.5	10.5	-8.25	0	0	0
19	11	14.75	-8.75	11	14.75	-9	0	0	-0.25
20	11	20	-8.75	11	20	-9	0	0	-0.25
21	11	25.5	-9	11	25.5	-9.25	0	0	-0.25
22	11	30.25	-9	10.75	30	-9.5	-0.25	-0.25	-0.5
23	6.75	15.25	-8.75	6.5	15.25	-9	-0.25	0	-0.25
24	6.75	20.5	-9	6.5	20.5	-9.25	-0.25	0	-0.25
25	6.75	27.25	-9	6.75	27.5	-9.5	0	0.25	-0.5
26	0.5	13.75	-4.75	0.5	13.75	-4.75	0	0	0
27	0.75	19.25	-5	0.75	19	-5	0	-0.25	0
28	0.75	26.5	-5	0.75	26.5	-5	0	0	0
29							0	0	0
30							0	0	0
31							0	0	0

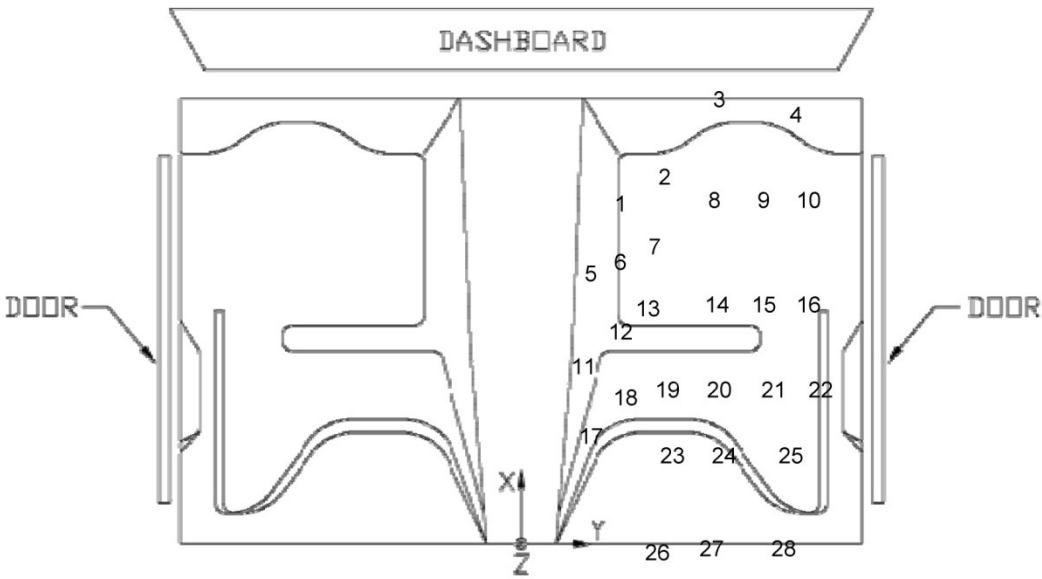

Figure C-1. Floor Pan Deformation Data – Set 1, Test No. KSFRP-1

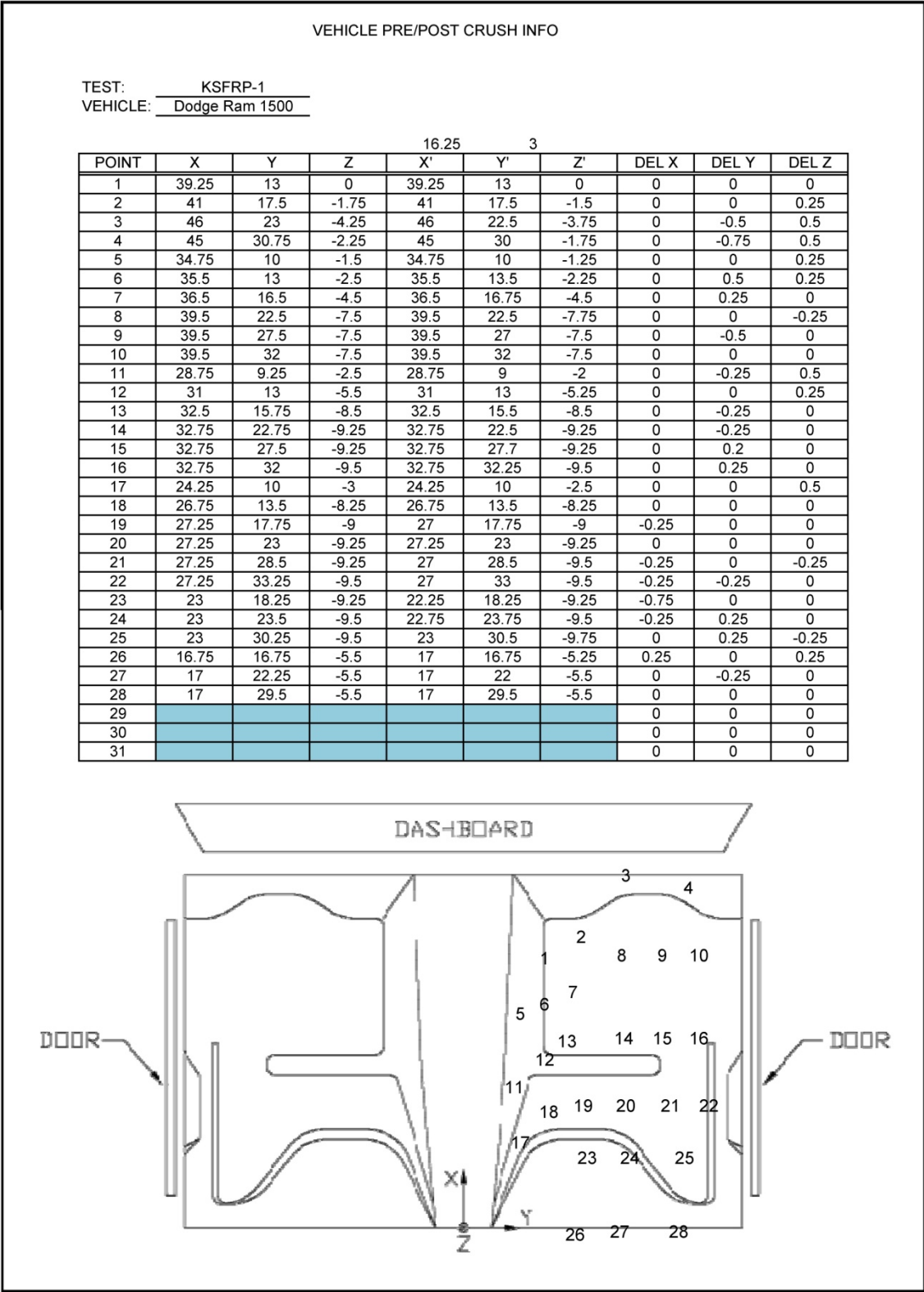

Figure C-2. Floor Pan Deformation Data – Set 2, Test No. KSFRP-1

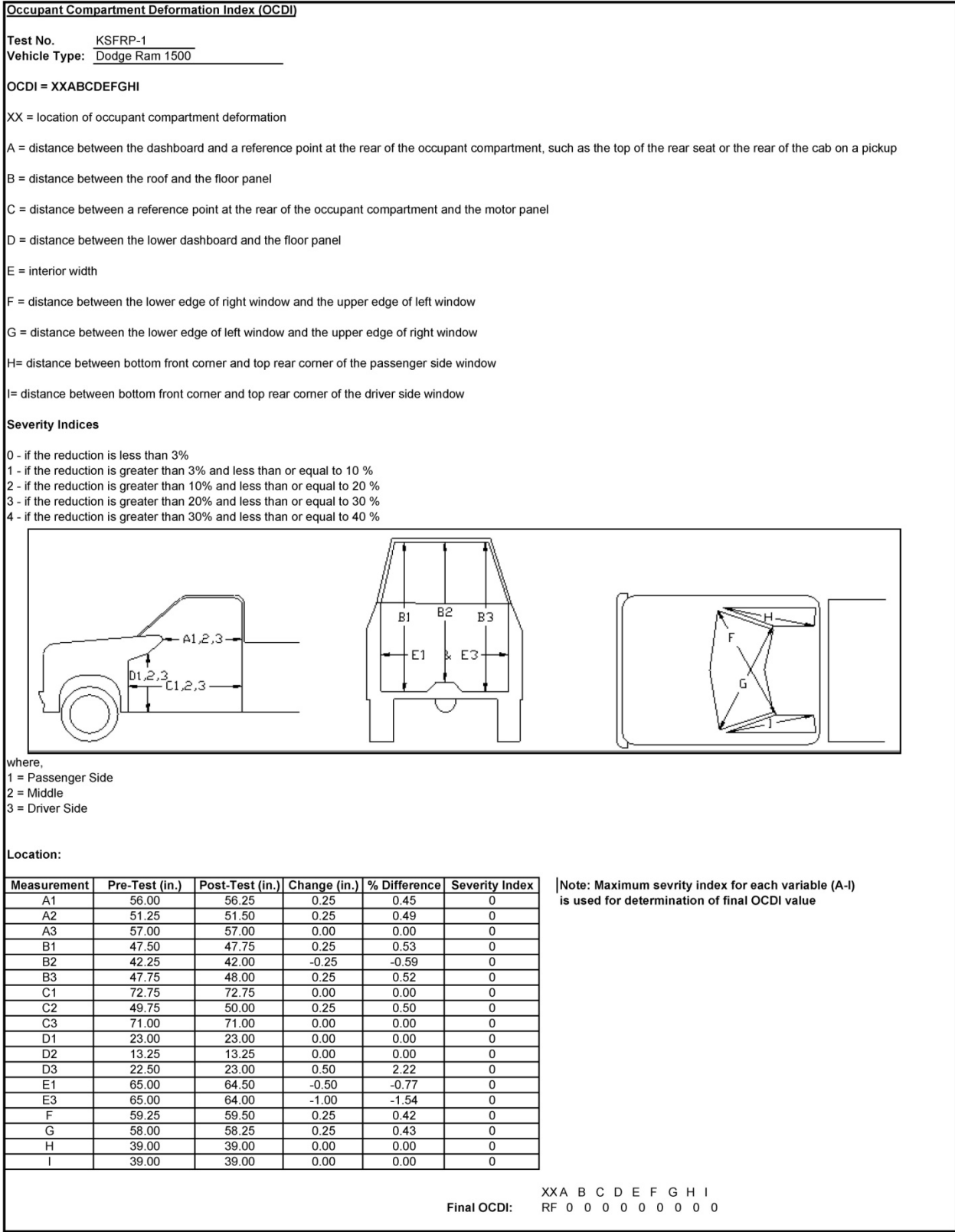
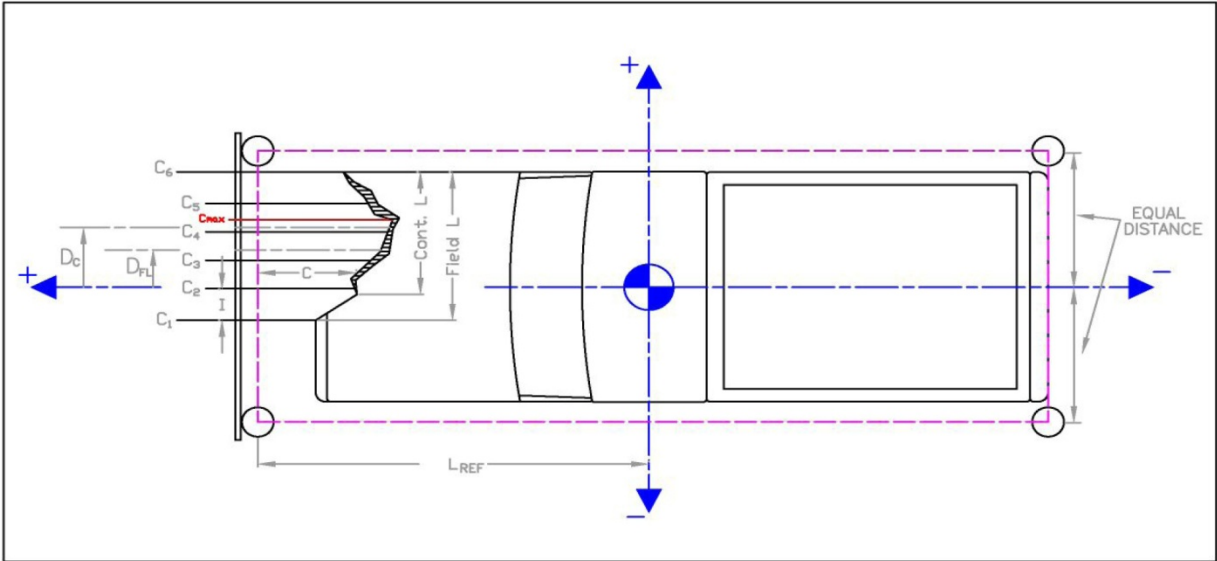

Figure C-3. Occupant Compartment Deformation Index, Test No. KSFRP-1

Date: 3/13/2009 Test Number: KSFRP-1
Make: Dodge Model: Ram 1500 Year: 2002



	in.	(mm)
Distance from C.G. to reference line - L_{REF} :	117	(2972)
Width of contact and induced crush - Field L:	19	(483)
Crush measurement spacing interval (L/5) - I:	3.8	(97)
Distance from center of vehicle to center of Field L - D_{FL} :	28.5	(724)
Width of Contact Damage:	15.5	(394)
Distance from center of vehicle to center of contact damage - D_C :	18.5	(470)

	Crush Measurement		Lateral Location		Original Profile Measurement		Dist. Between Ref. Lines		Actual Crush	
	in.	(mm)	in.	(mm)	in.	(mm)	in.	(mm)	in.	(mm)
C_1	17.75	(451)	19	(483)	12.3125	(313)	5.17103	(131)	0.26647	(7)
C_2	20.25	(514)	22.8	(579)	13.2344	(336)			1.8446	(47)
C_3	28.5	(724)	26.6	(676)	14.6875	(373)			8.64147	(219)
C_4	41.25	(1048)	30.4	(772)	16.2969	(414)			19.7821	(502)
C_5	41.25	(1048)	34.2	(869)	19.25	(489)			16.829	(427)
C_6	42.25	(1073)	38	(965)	29	(737)			8.07897	(205)
C_{MAX}	42.25	(1073)	19	(483)	12.3125	(313)			24.7665	(629)

Figure C-4. Exterior Vehicle Crush (NASS) - Front, Test No. KSFRP-1

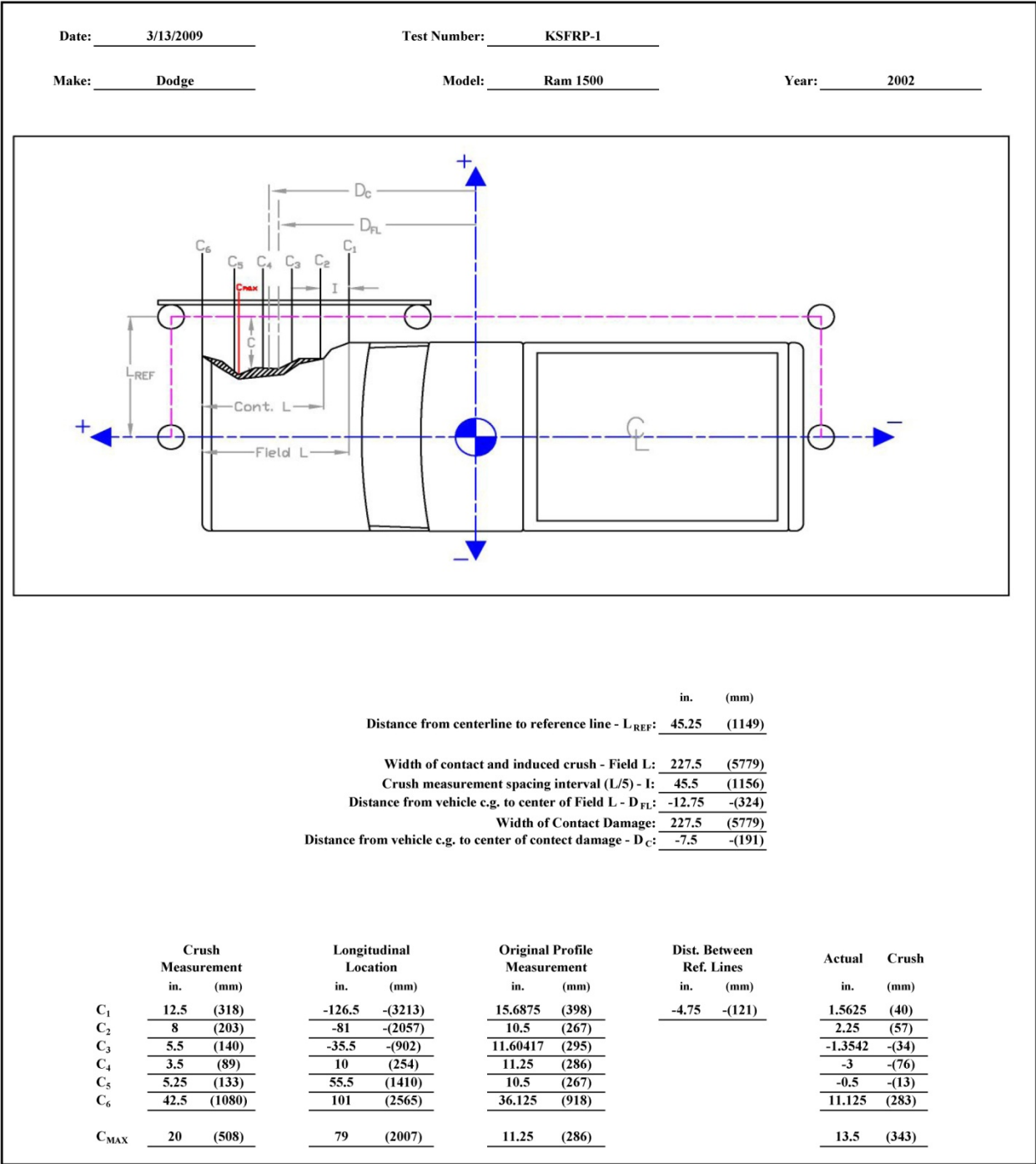

Figure C-5. Exterior Vehicle Crush (NASS) - Side, Test No. KSFRP-1

Appendix D. Accelerometer and Rate Transducer Data Plots, Test No. KSFRP-1

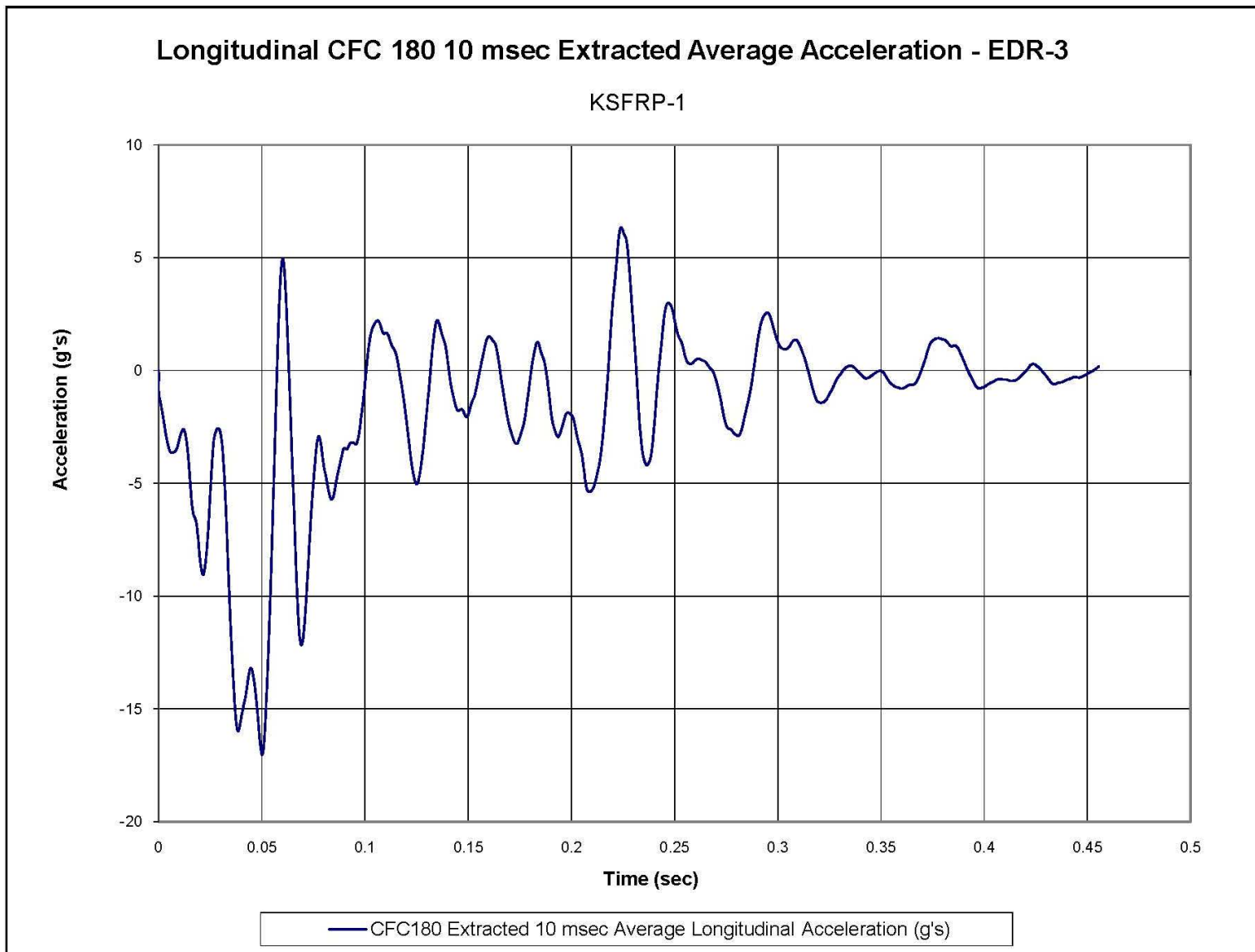

Figure D-1. 10-ms Average Longitudinal Deceleration (EDR-3), Test No. KSFRP-1

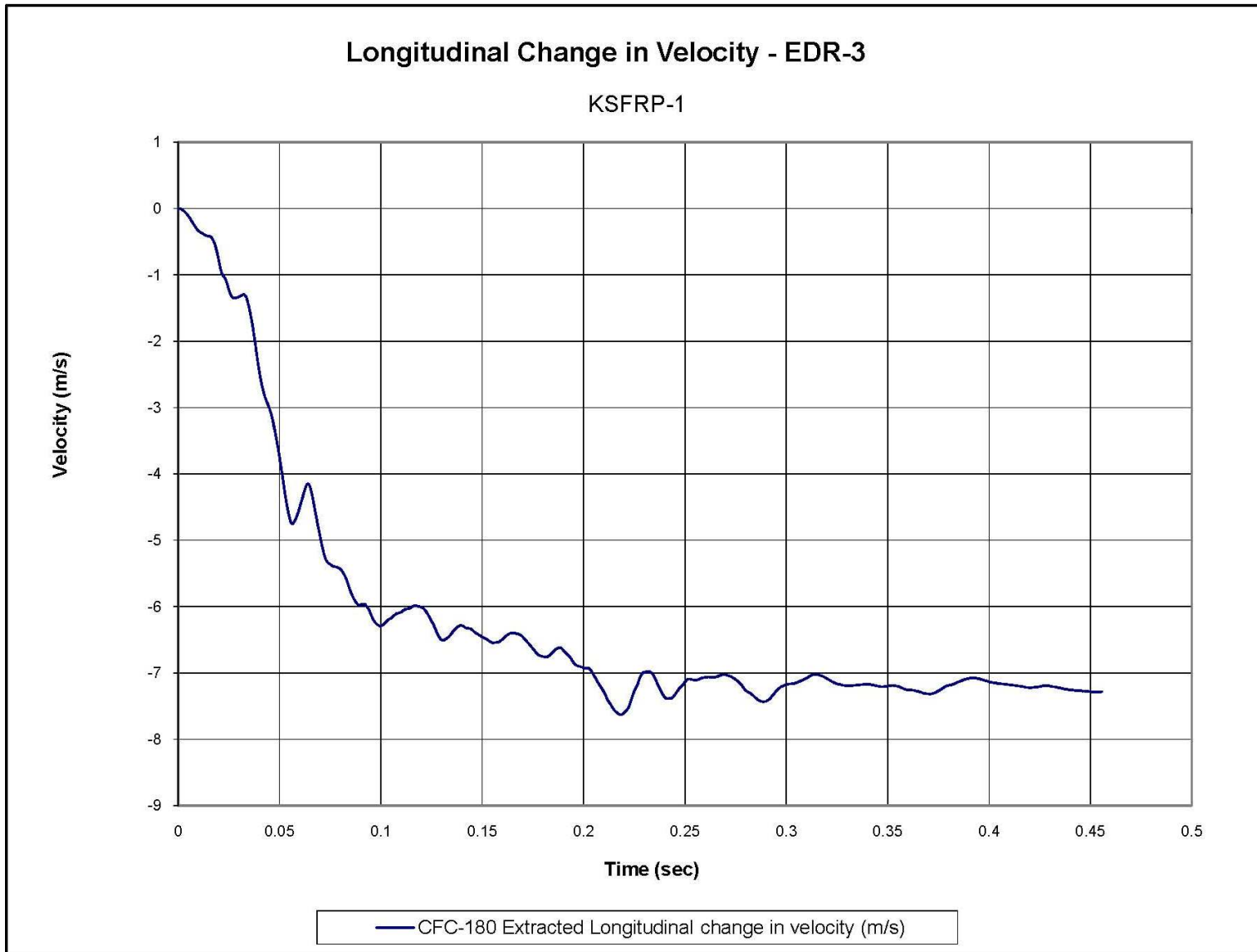

Figure D-2. Longitudinal Occupant Impact Velocity (EDR-3), Test No. KSFRP-1



Figure D-3. Longitudinal Occupant Displacement (EDR-3), Test No. KSFRP-1

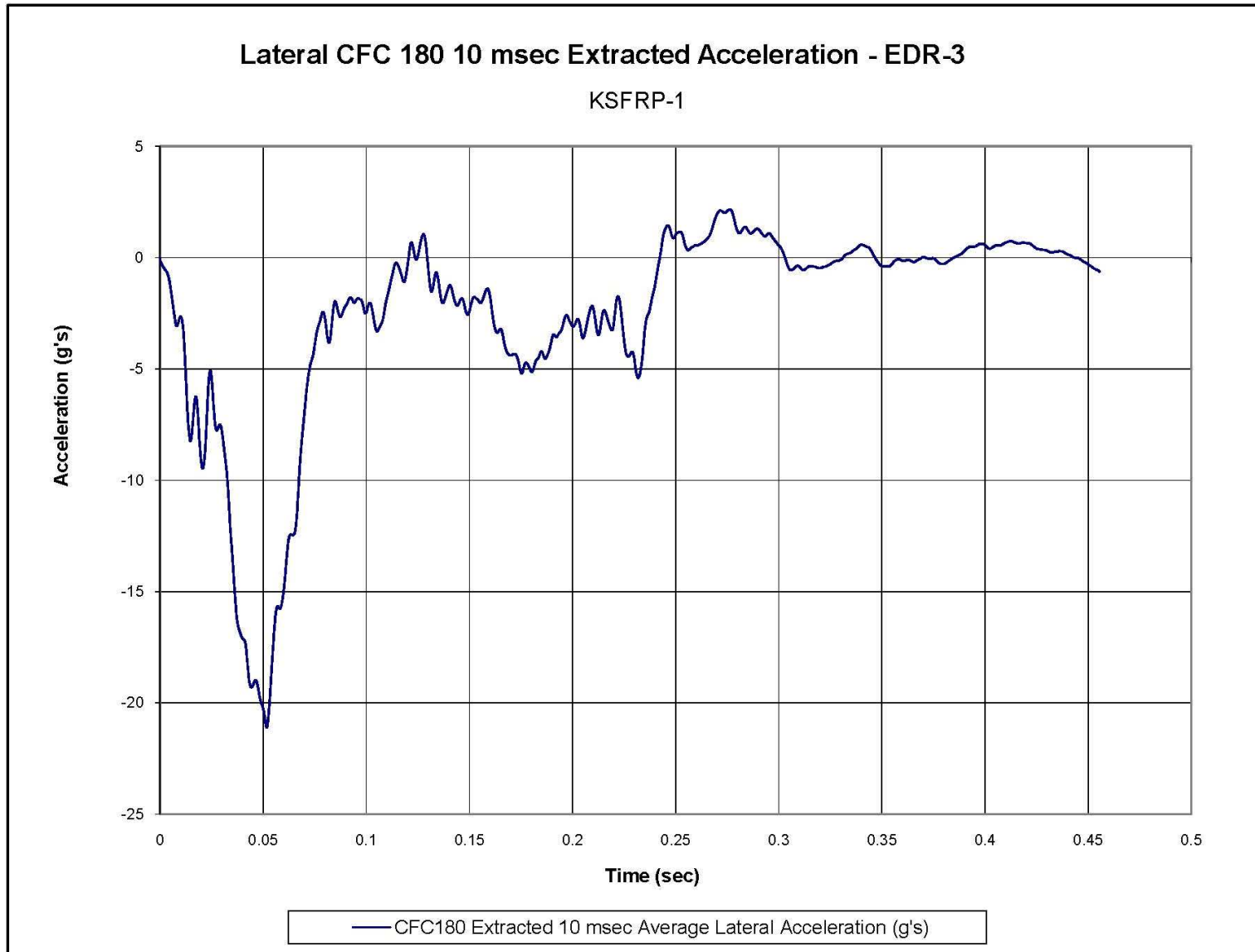

Figure D-4. 10-ms Average Lateral Deceleration (EDR-3), Test No. KSFRP-1

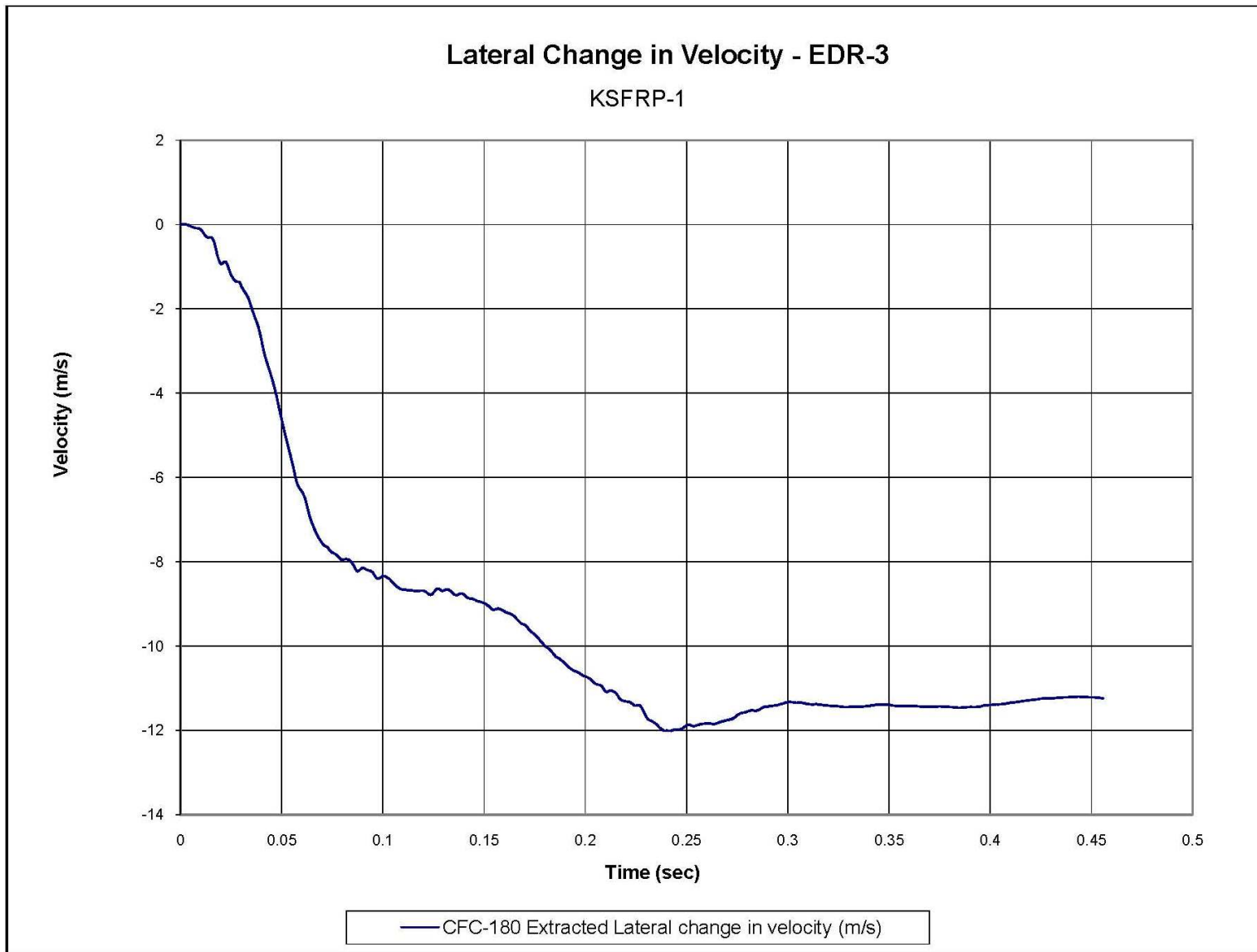

Figure D-5. Lateral Occupant Impact Velocity (EDR-3), Test No. KSFRP-1



Figure D-6. Lateral Occupant Displacement (EDR-3), Test No. KSFRP-1

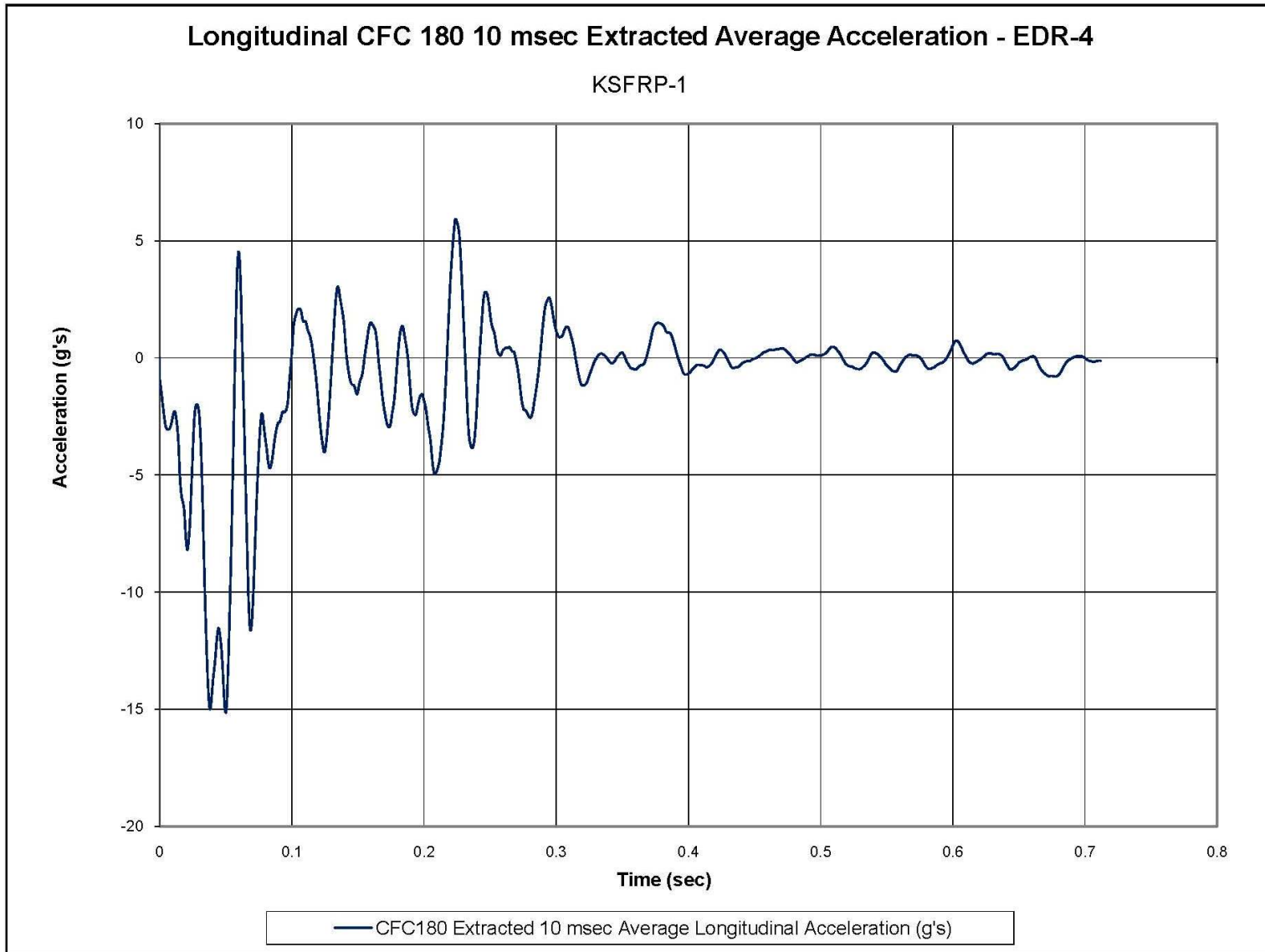

Figure D-7. 10-ms Average Longitudinal Deceleration (EDR-4), Test No. KSFRP-1

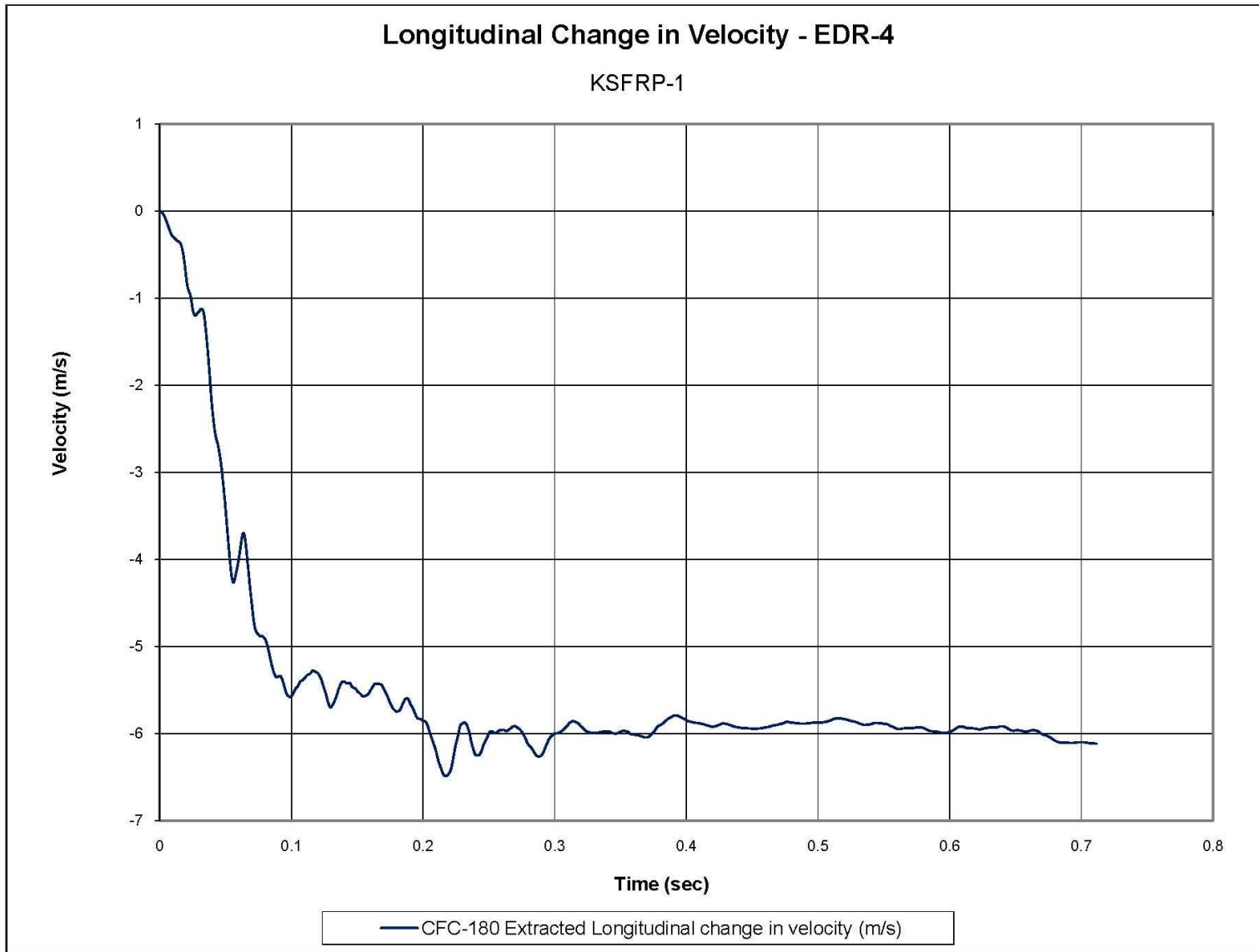

Figure D-8. Longitudinal Occupant Impact Velocity (EDR-4), Test No. KSFRP-1

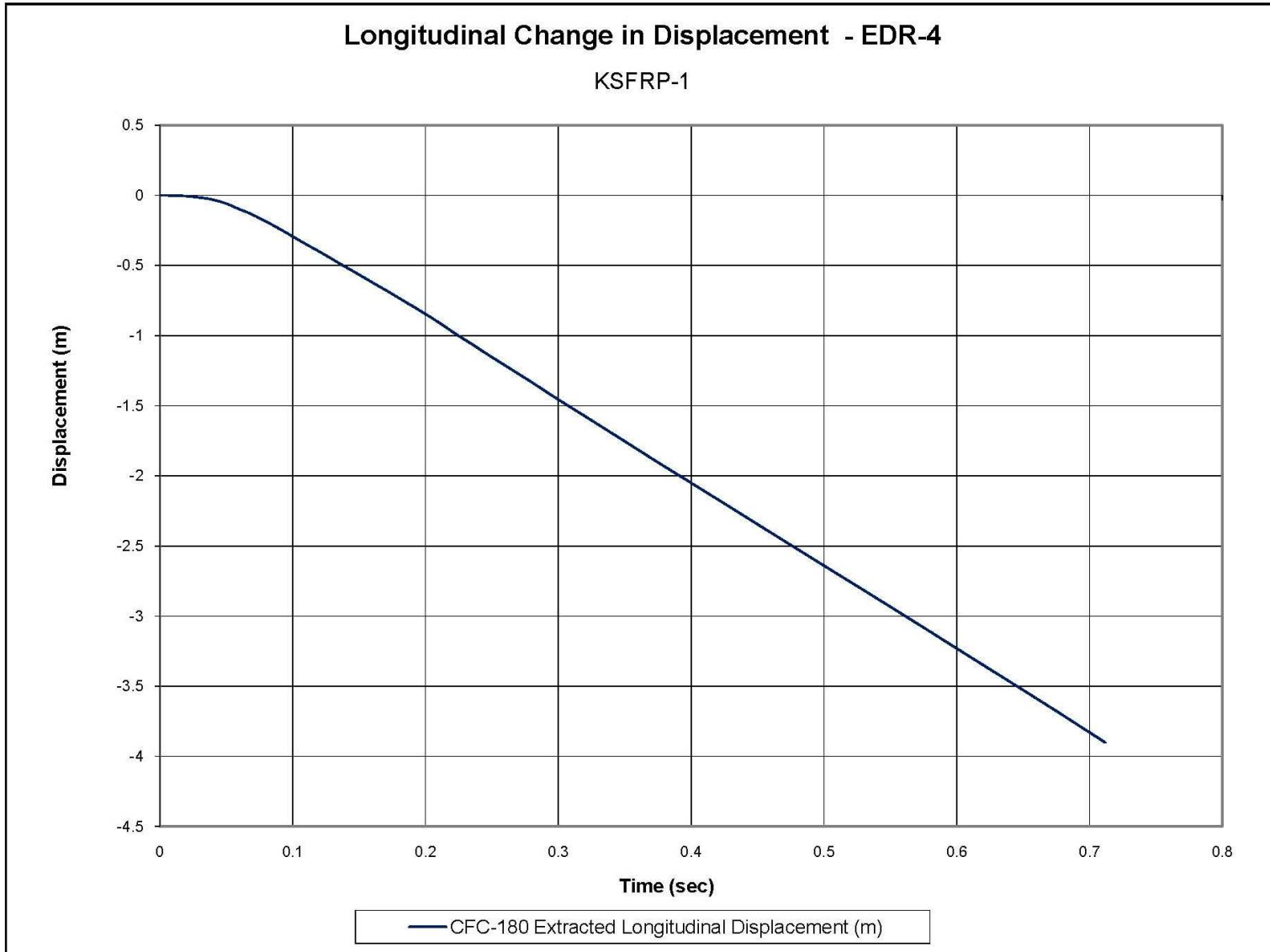

Figure D-9. Longitudinal Occupant Displacement (EDR-4), Test No. KSFRP-1

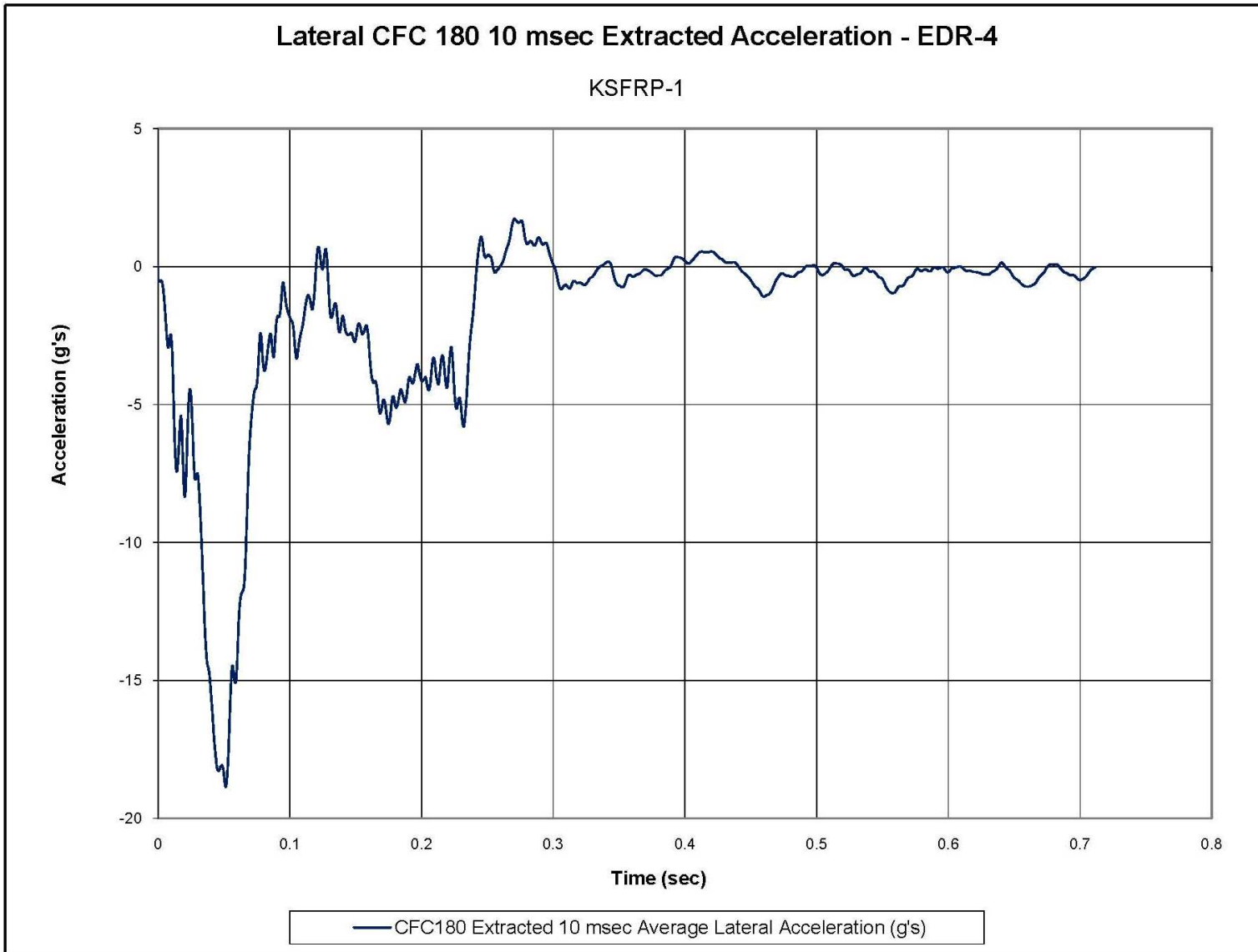

Figure D-10. 10-ms Average Lateral Deceleration (EDR-4), Test No. KSFRP-1

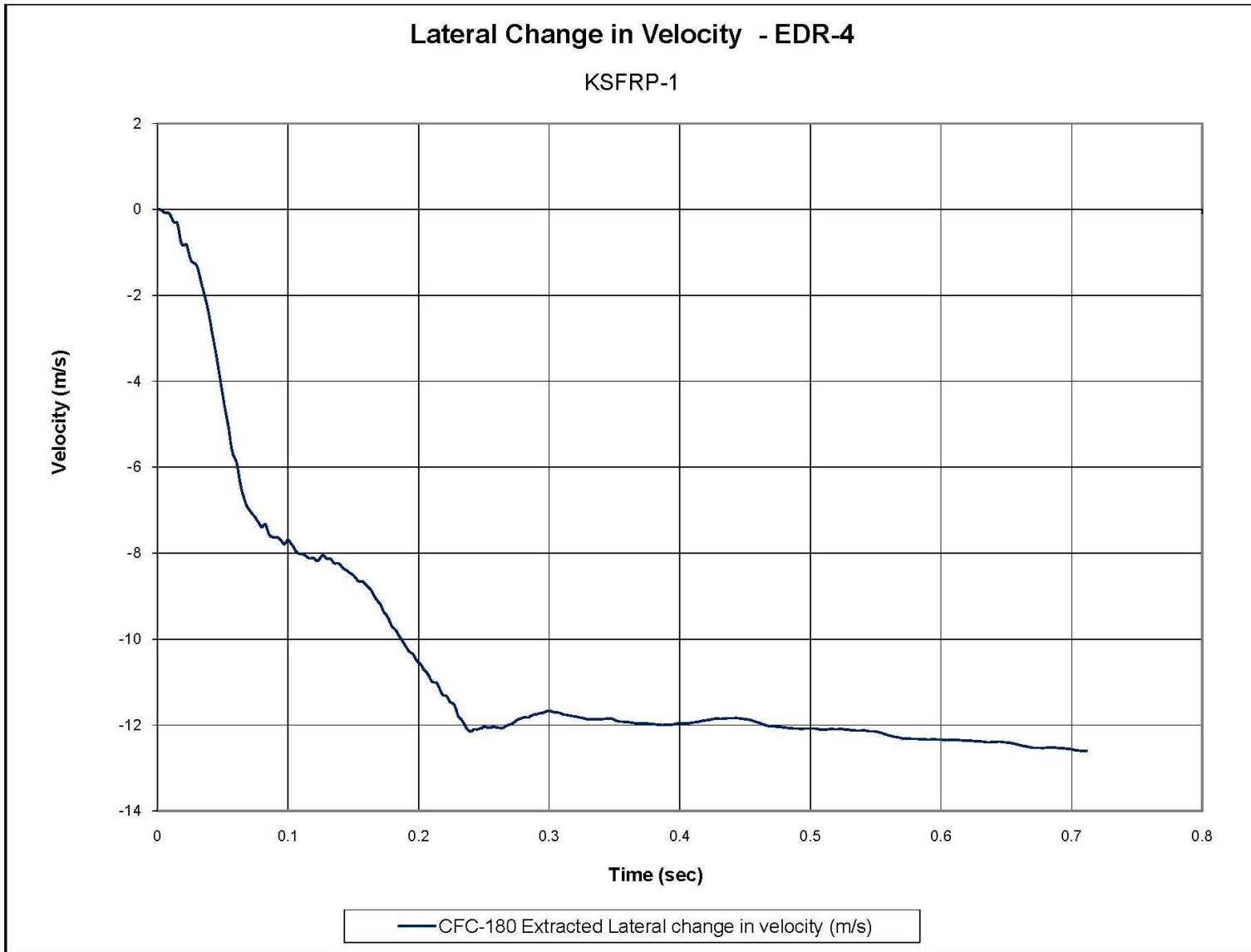

Figure D-11. Lateral Occupant Impact Velocity (EDR-4), Test No. KSFRP-1

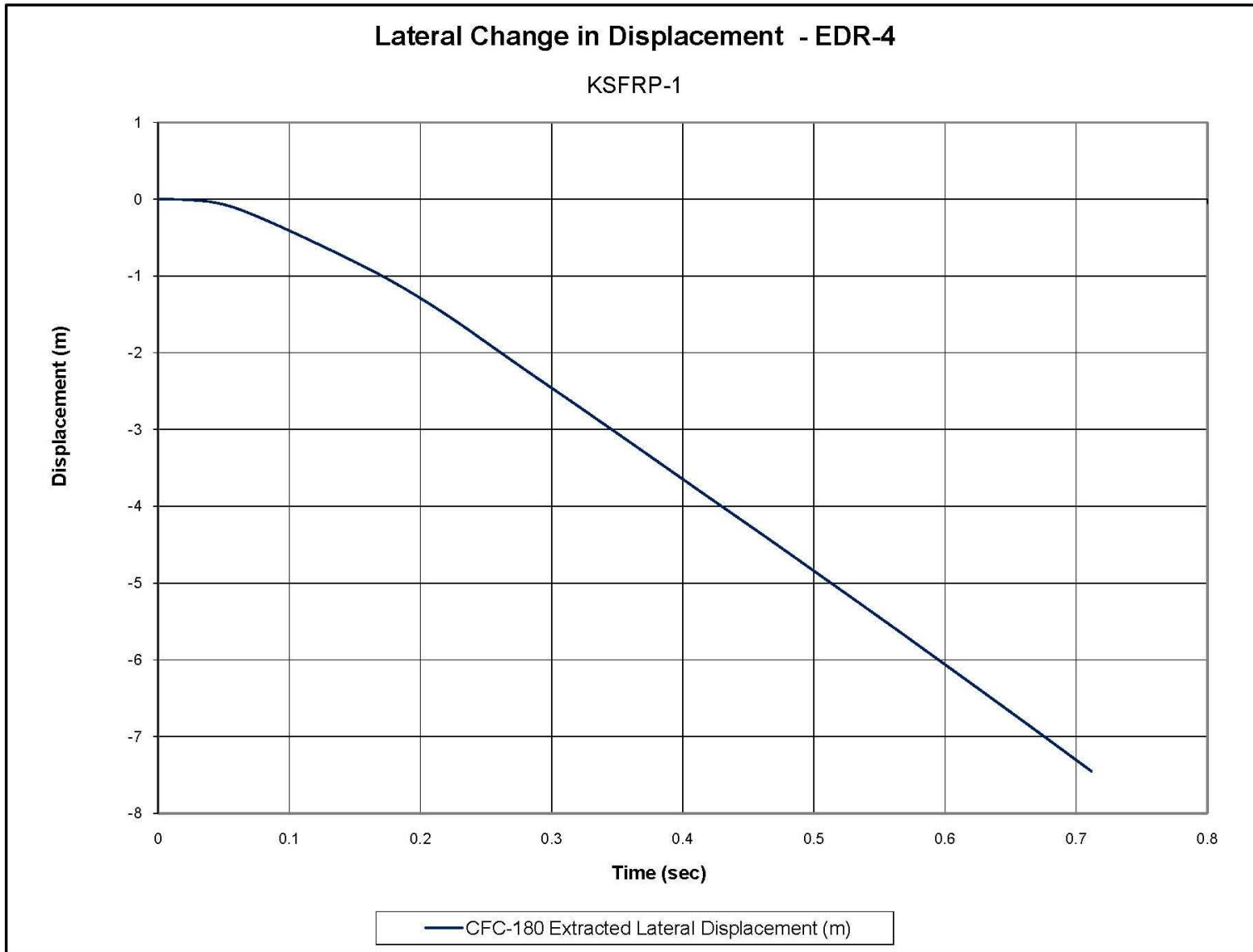

Figure D-12. Lateral Occupant Displacement (EDR-4), Test No. KSFRP-1



Figure D-13. Vehicle Angular Displacements (EDR-4), Test No. KSFRP-1

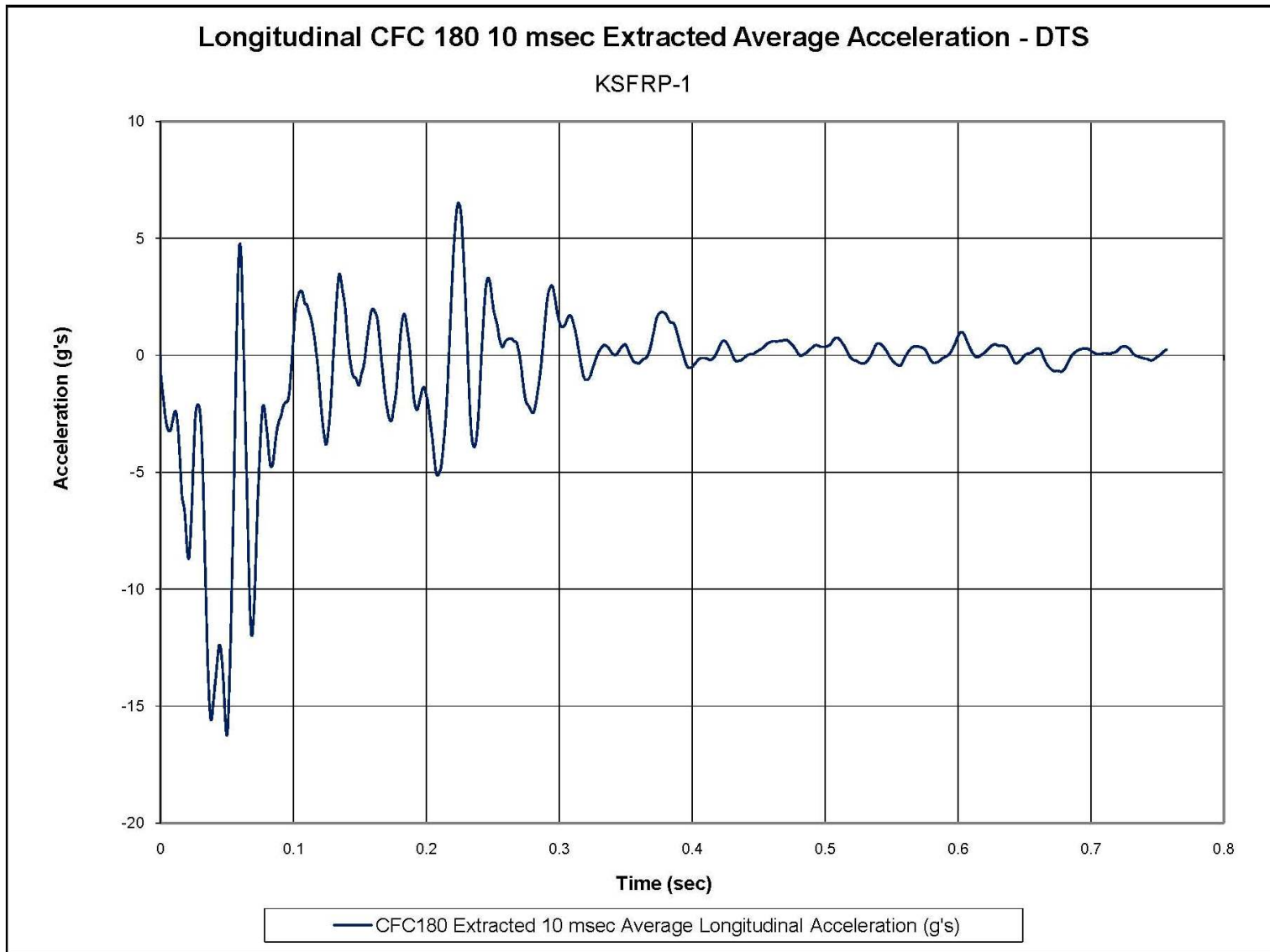

Figure D-14. 10-ms Average Longitudinal Deceleration (DTS), Test No. KSFRP-1

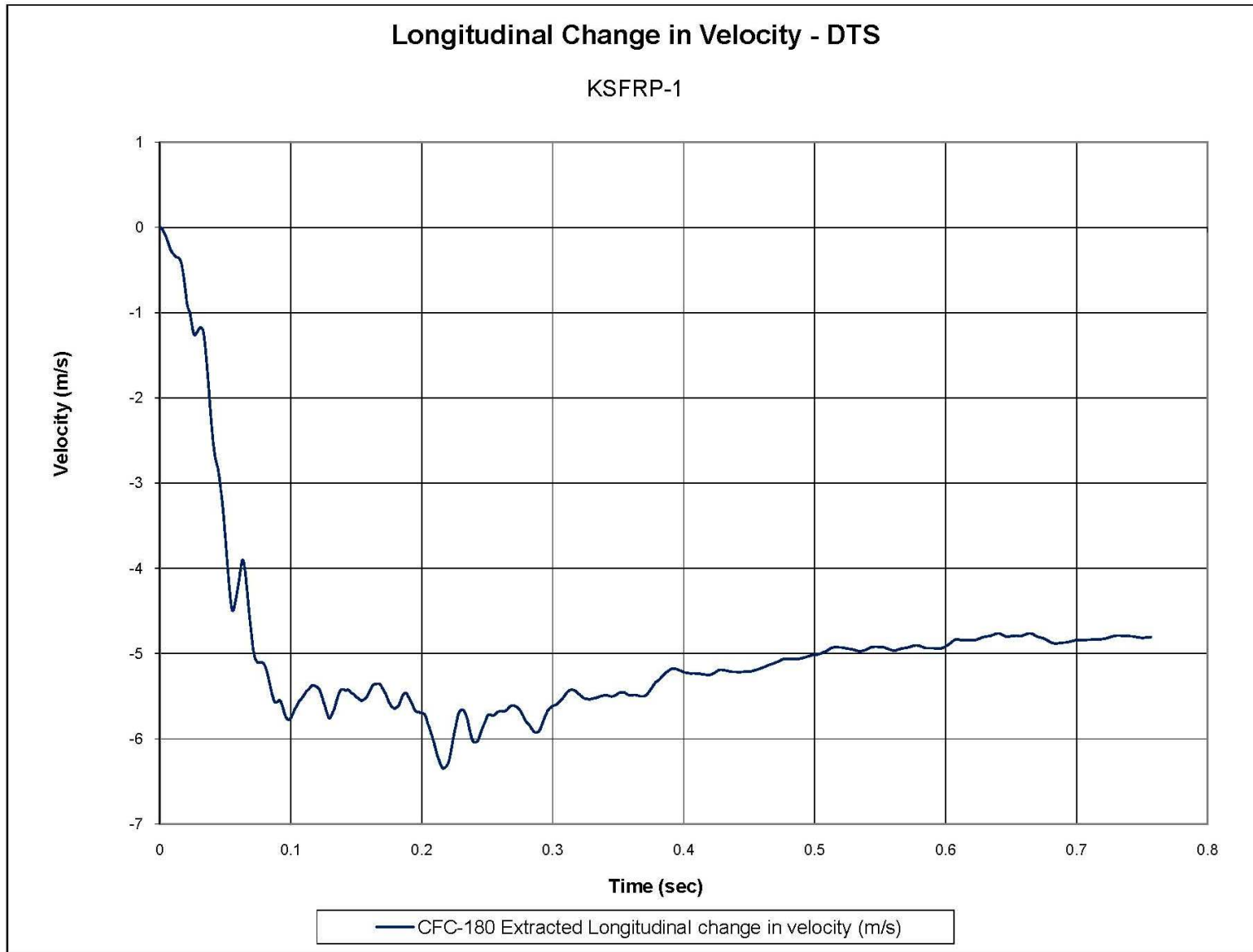

Figure D-15. Longitudinal Occupant Impact Velocity (DTS), Test No. KSFRP-1

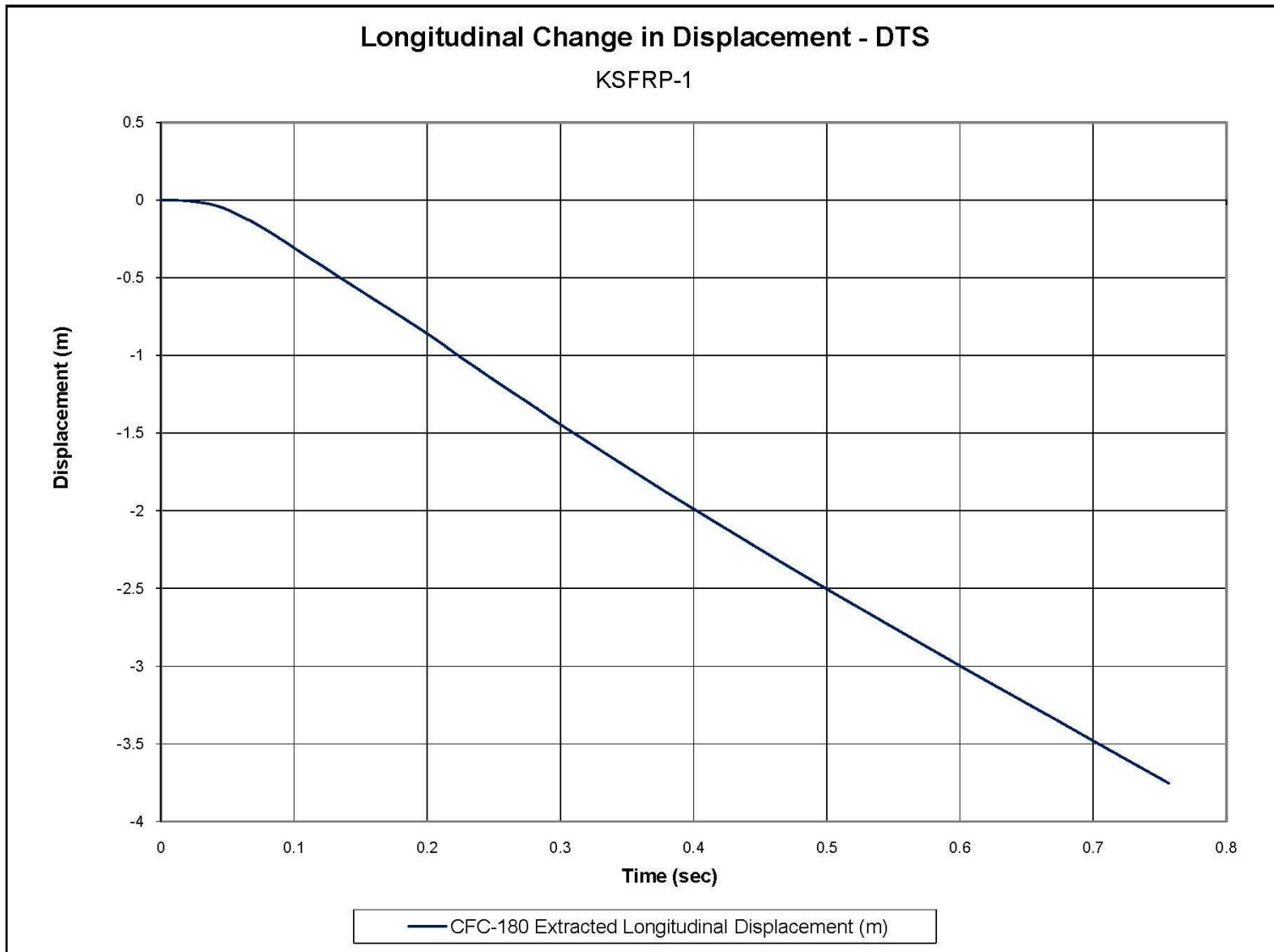

Figure D-16. Longitudinal Occupant Displacement (DTS), Test No. KSFRP-1

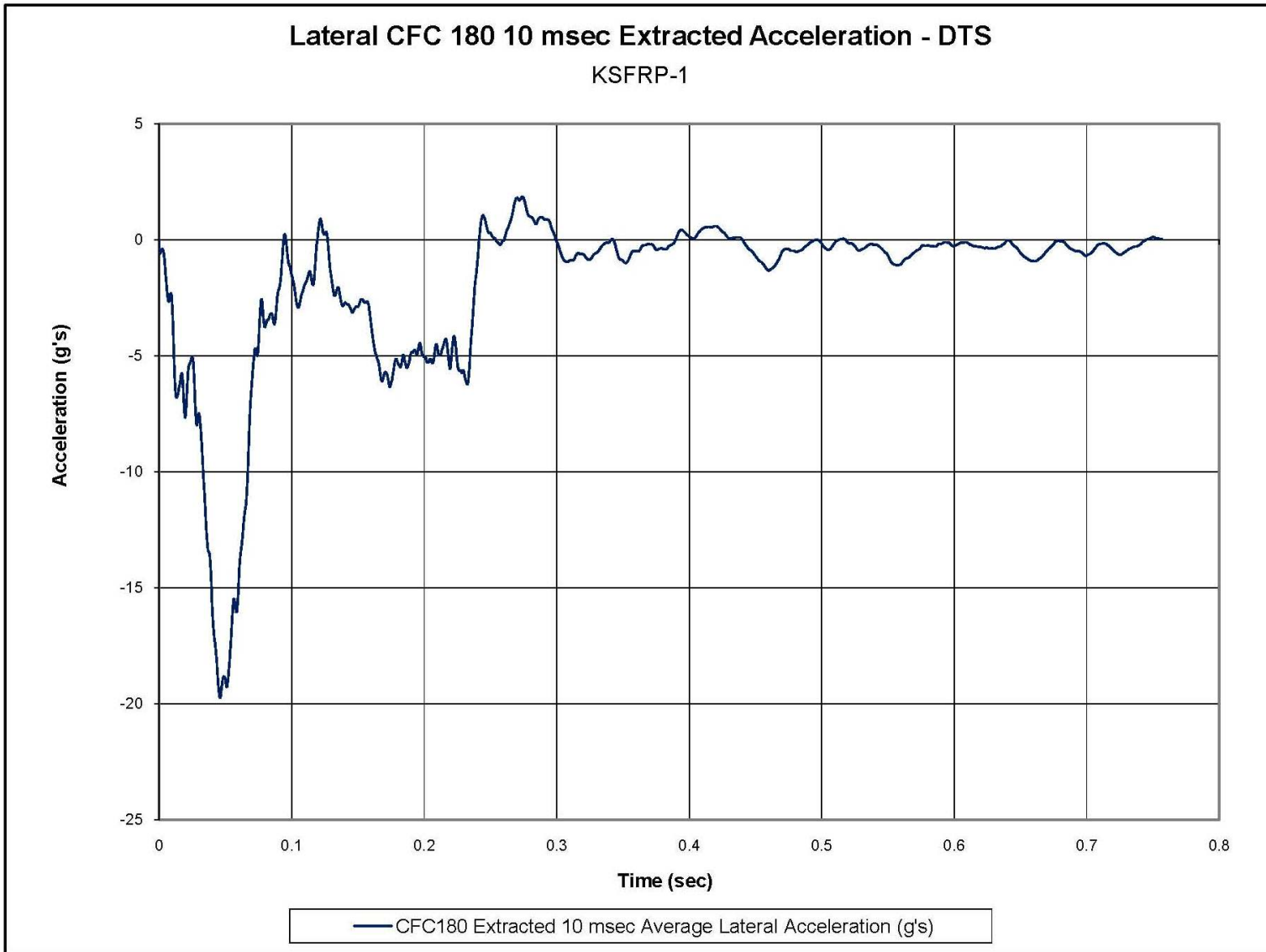

Figure D-17. 10-ms Average Lateral Deceleration (DTS), Test No. KSFRP-1

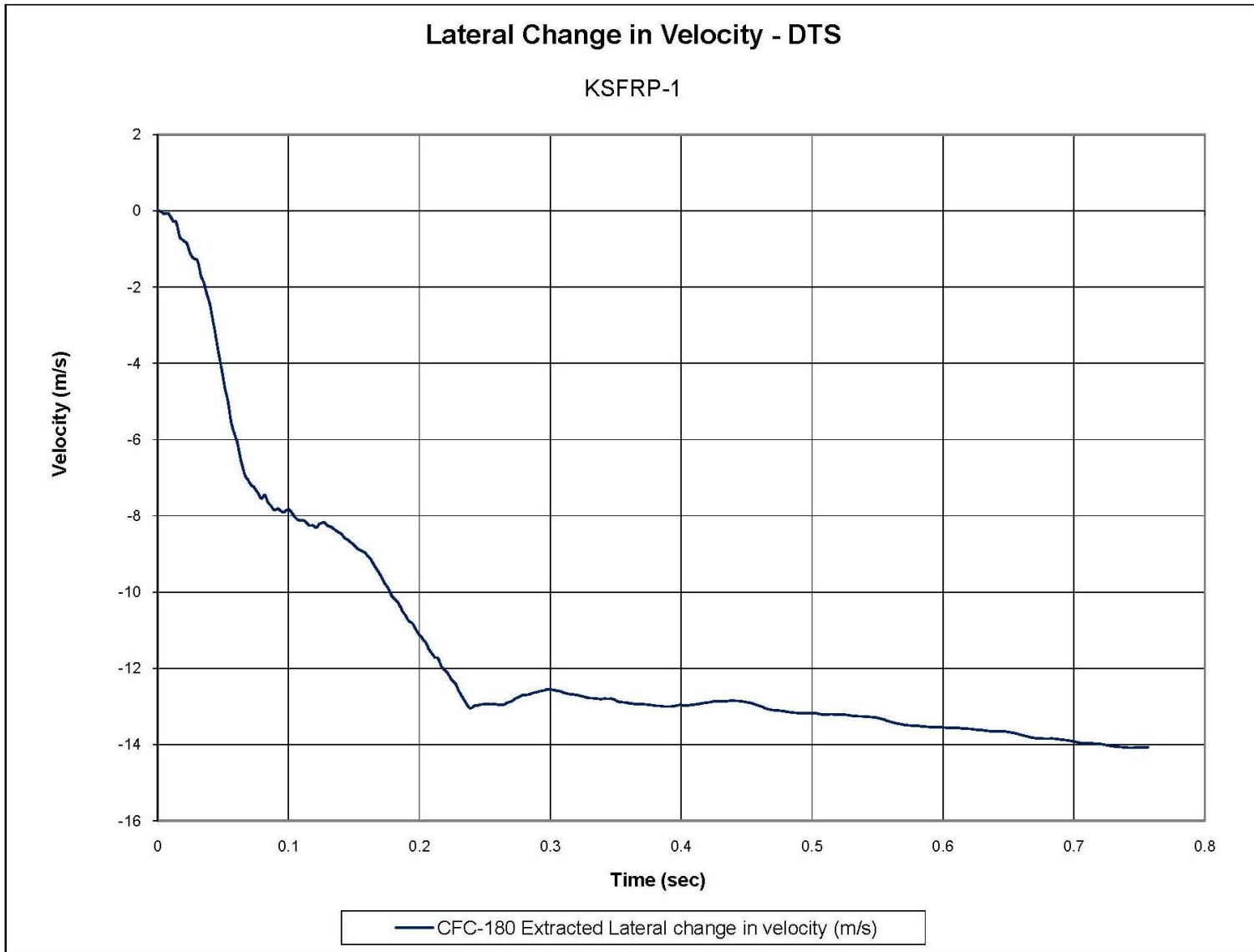

Figure D-18. Lateral Occupant Impact Velocity (DTS), Test No. KSFRP-1

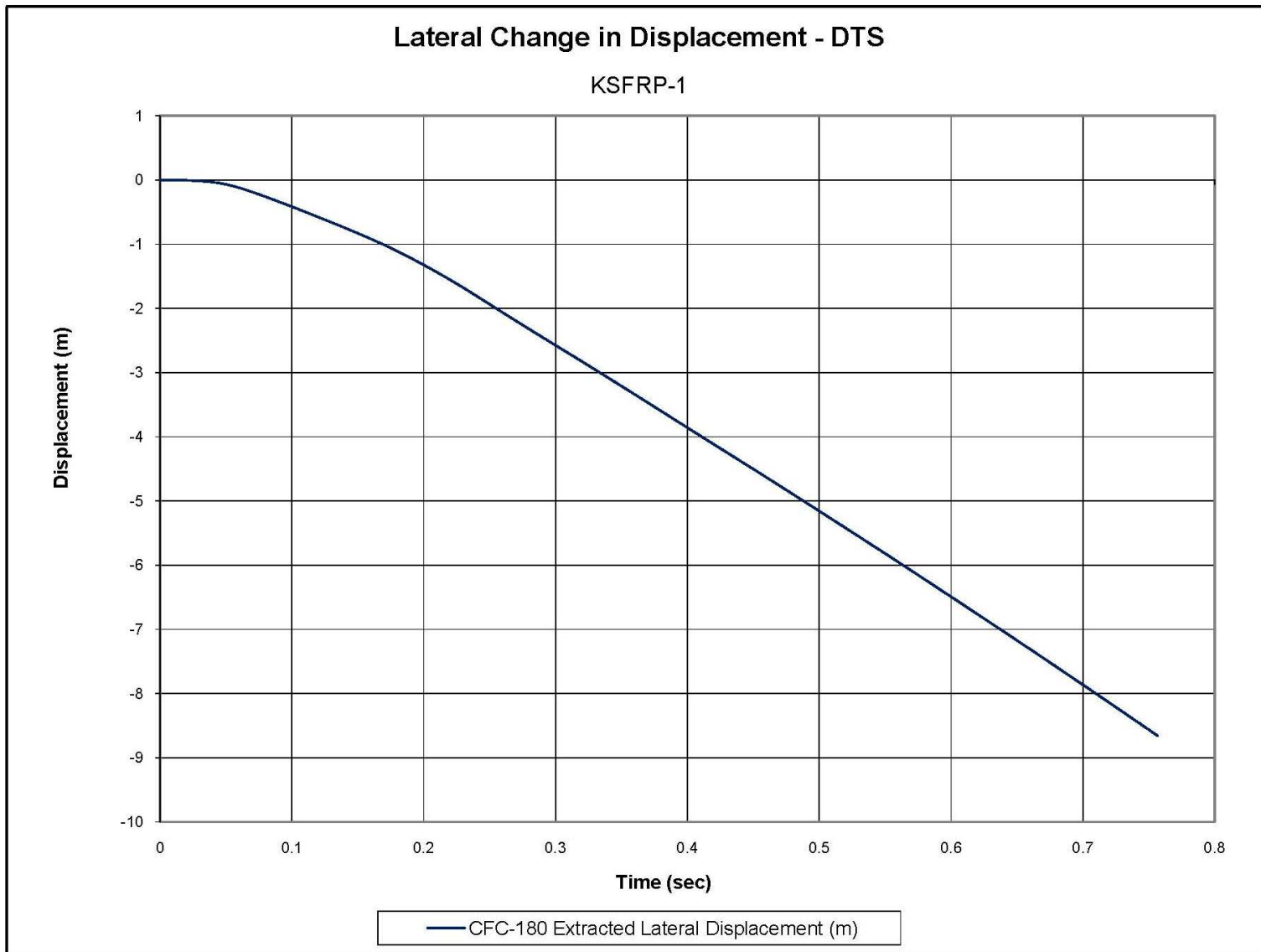

Figure D-19. Lateral Occupant Displacement (DTS), Test No. KSFRP-1

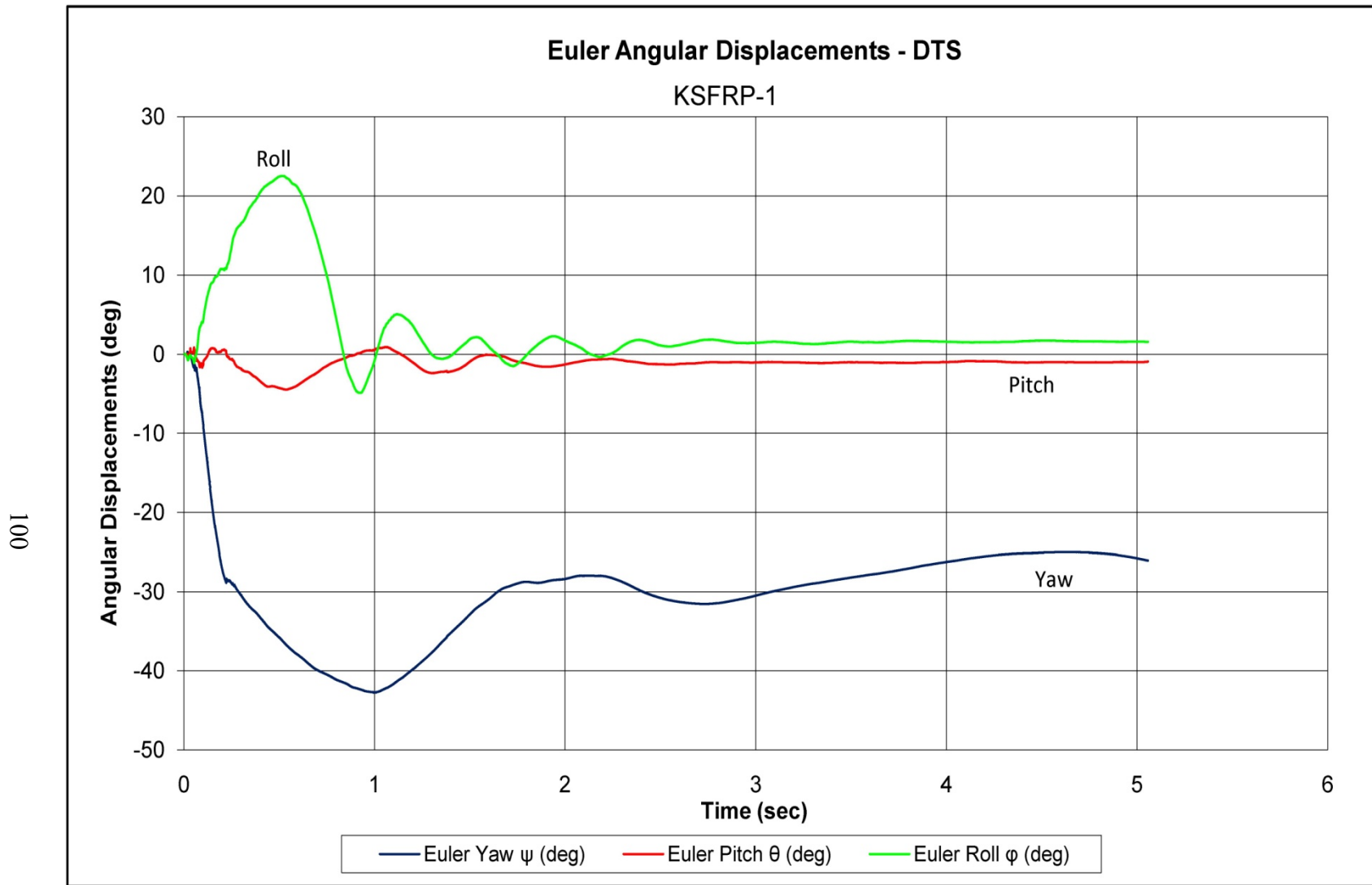

Figure D-20. Vehicle Angular Displacements (DTS), Test No. KSFRP-1

END OF DOCUMENT